



b.hyve[™]
AG CENTRE PIVOT
REMOTE CONTROL

PIVOT PARTS & COMPONENTS

January 2026

IRRICO 

YOUR GLOBAL IRRIGATION PARTNER

IRRICO

GEARBOXES	7
Irrico 740L & 740V Gearboxes	7
Irrico 760L & 760V Gearboxes	7
Irrico Towable Gearboxes	7
Irrico Planetary Gearboxes	8
CENTRE DRIVES	8
Irrico Centre Drives	8
COUPLERS	
Irrico Standard Coupler, SC3 & Black Max Universal Driveline Couplers	9
WHEELS & TYRES	
Irrico Wheels, Tyres & Tubes	10
IRRICO BOOSTER PUMPS	10
IRRICO-L TOWER BOXES	
Irrico-L Intermediate Tower Box	11
Irrico-L Stall Tower Box	11
Irrico-L Last Tower Box	11
Irrico-L Booster Pump Tower Box	12
Irrico-L Tower Box Base	12
Irrico-L Tower Box Cover	12
Irrico-L Cam	13
Irrico-L Cam Arm	13
Irrico-L Cam Arm Spring	13
Irrico-L Cam Arm Bolt, Nut & Washer	13
Irrico-L Stainless Linkage Kit	14
Irrico-L Stainless Linkage Rod	14
Irrico-L Stainless Quick Disconnect	14
Irrico-L Stainless Ball Swivel Joint Adjuster	14
IRRICO-L STRUCTURAL COMPONENTS	
Irrico-L Complete Centre Point	15
Irrico-L Pivot Elbow	16
Irrico-L Pivot Head	16
Irrico-L Pivot Riser Pipe	16
Irrico-L Bottom Inlet Elbows	17
Flange Galvanised Pipe Reducer	17
Irrico-L Centre Point Riser Straps	18
Irrico-L Heavy Duty Centre Point Legs & Tie Angles	18
Irrico-L Non-Tow Pivot Anchor Kit	18
Irrico-L Non-Tow Pivot Anchor Bolt	18
Irrico-L Upper Panel Mount Bracket	19
Irrico-L Lower Panel Mount Bracket	19
Irrico-L Tower Box Mounting Brackets	19
Irrico-L Pivot End Joint	20
Irrico-L Tower End Joint	20
Irrico-L Reducing Tower Joint	20
Irrico-L Last Tower Joint	20
Irrico-L Alignment Ring	21
Irrico-L 61m Span Spacer Flange	21
Irrico-L Span Pipes & Overhang Kits	21
Irrico-L Sand Trap Kit	22
Irrico-L End of Machine Flange Plate	22
Irrico-L 8" Weld On Coupler (Black)	22
Steel Coupler Clamps	22
Bushes & Plugs	23
Nipple 2 ½" Male	23
Irrico-L Drain Plugs	23
Irrico-L Drive Tubes	24
Irrico-L Drive Shaft	24
Irrico-L Drive Shaft Cover 1 ½" x 54"	24
Irrico-L Washer Drive Shaft Bell	25

Irrico-L Bell Drive Shaft End 4 1/8"	25
Irrico-L Bell Drive Shaft End 5 1/4"	25
Worm Drive Hose Clamp	25
Irrico-L Tie Rod	26
Irrico-L Tie Rod Brackets	26
Irrico-L Tower Tie Angle Kit	26
Irrico-L Truss Angle Plate 6 5/8" & 8"	27
Irrico-L Brace and Tie Angle Packs/Truss Angle Sets	27
Irrico-L Stabilizer Angles	28
Irrico-L Stabilizer Ties	28
Irrico-L Span Tower Leg 11'	28
Irrico-L Upper Leg Clamp	29
Irrico-L Lower Leg Clamp	29
Irrico-L Span Bolt Kit	29
End Of Field Switch Bracket & Switch Kit	30
Goosenecks Galvanised 3/4" 180 degree	30
Poly Dropper Weight	30
IRRICO-V STRUCTURAL COMPONENTS	
Irrico-V Intermediate Tower Box	31
Irrico-V Stall Tower Box	31
Irrico-V Last Tower Box	31
Irrico-V Auto Reverse Tower Box	31
Irrico-V Booster Pump Tower Box	32
Irrico-V Auto Stop Tower Box	32
Irrico-V Tower Box Lid	32
Irrico-V Tower Box Control Bar & Keeper Plate	32
Irrico-V Complete Centre Point	33
Irrico-V Pivot Upper Elbow Swivel Assembly	34
Irrico-V Riser Pipe Coupling Clamp and Bearing	34
Irrico-V Pivot Head	34
Irrico-V Riser Pipe	34
Irrico-V Bottom Inlet Elbow	35
Irrico-V J Tube & Packings	35
Irrico-V Pivot Point Heavy Duty Legs & Angles	35
Irrico-V Non-Towable Pivot Foot	36
Irrico-V Pivot Tie Down Bolts	36
Irrico-V Hinge Joint	36
Irrico-V First Pipe	37
Irrico-V Swivel Stub Pipe	37
Irrico-V Fixed Stub Pipe	37
Irrico-V Last Stub Pipe	37
Irrico-V End Plates	38
Irrico-V Span Pipes & Overhang Kits	38
Irrico-V Stabilizer Clamp	39
Irrico-V Span Tower Legs & Brace Angles	39
Irrico-V Main Panel Mount Angles	39
Irrico-V Drive Shaft	40
Irrico-V Drive Shaft Shield Tubes	40
Irrico-V Drive Coupling Shield	40
Irrico-V Trapezoid Gusset and Tower Reinforcing Plate	41
Irrico-V Tower Support & Upper Brace Pipes	41
Irrico-V Tower Tie Brace Angle	41
Irrico-V Tower Base Beam Non-Towable	41
Irrico-V Truss Angle Sets and Packages	42
Irrico-V Truss Rod	43
Irrico-V Truss Rod Clamp Outer and Inner	43
Irrico-V Hardware Kit	43
End Stops	44
SPAN BOOT HOSE, CLAMPS & GASKETS	
Irrico-L Couplers & Boots	45

Irrico-V Span Boot Hose	45
Irrico-V Span Boot T-Bolt Clamps	45
Irrico-L Span Pipe Gaskets	46
Irrico-L Riser Pipe Sealing Washers, Nuts and Bolts	46
Irrico Triple Lip Gaskets	46
Irrico-V Span Pipe Gaskets	47
Irrico-V Flat Gaskets	47
PIVOT STROBE LIGHT & GLOBE	47
End of Pivot LED Strobe Light Kit	47
White Edison Screw LED Corn Globe	47
PERCENTAGE TIMERS	48
Percentage Timers	48
COLLECTOR RINGS	48
Irrico-L Collector Ring	48
Irrico-V Collector Rings	48
ELECTRICAL COMPONENT SPARES	49
Copper Earth Rod and Wire	49
Galvanised Earth Rod	49
Lightning Arrestor	49
Electrical Cable	50
Speed Clips "S"	50
Span Cable Clips	50
Irrico-L Micro Switch Long Arm	51
Irrico-V Micro Switch Short Arm	51
Pressure Switches	51
Pressure Transducers	52
Irrico-L Collector Ring Brushes	52
Irrico-V Collector Ring Brushes	52
Changeover Switch 6-Pole	52
CONTACTORS, TRANSFORMERS & SWITCHES	53
AC Contactor UL & CE:3P&4P	53
AC Contactor Schneider	54
Main Panel Circuit Breaker Schneider	54
Main Panel Transformer	54
SOLID STATE TIMERS	54
CONTROL SYSTEMS	55
Standard Control Panel	55
B-Hyve AG Remote Pivot Control	55
IRRICO VALVES	56
AIR RELIEF VALVES	56
IRRICO SPRINKLERS	57
XCAD USA	
END OF PIVOT SPRINKLERS & NOZZLES	59
XCAD Axis Sky Sprinkler	59
XCAD Axis Field Sprinkler	59
XCAD Axis X75 Black Bird Sprinkler	59
HIGH PRESSURE END GUNS	60
XCAD X100 Thunderbolt End Gun	60
XCAD X100 Nozzle	60
XCAD X100 Replacement Bearing Assembly	60
PIVOT SPRINKLERS	61
XCAD Radius Sprinklers & Jet Pack Dual Nozzle Rack	61
PIVOT REGULATORS	61
XCAD Regulators	61
VALVES	62
X-MAX Valves: Basic, Manual, Electric On/Off, Pressure Reducing, Pressure Sustaining	62
SEAL MATIC Valves: Basic, Manual, Electric On/Off, Pressure Reducing, Pressure Sustaining	63
X-MAX Valve Plumbing	64

DRAINS	65
XCAD Z Drain	65
XCAD V Drain	65
NELSON	
SPRINKLERS & PARTS	67
Nelson R3030 & R3000: Rotator	67
Nelson S3030 & S3000: Spinner	68
Nelson A3030 & A3000: Accelerator	69
Nelson O3030: Orbitor	70
Nelson D3030 & D3000: Sprayhead	70
LOW PRESSURE END GUNS	71
Nelson R55 & R55i End Gun	71
Nelson R75 & R75LP End Gun	72
HIGH PRESSURE END GUNS	73
Nelson End Gun Sprinklers	73
REGULATORS	74
Nelson Pressure Regulator	74
Nelson Pivot Pressure Regulators PPR ALL-FLO	74
SENNINGER	
SPRINKLERS & PARTS	76
Senninger I-Wob 2	76
Senninger XI-Wob	76
Senninger LDN Bracket	76
Senninger LDN Single Pad	77
Senninger LDN Double Pad	77
Senninger LDN Triple Pad	77
Senninger LDN Half Circle	77
Senninger LDN Shroud	78
Senninger UP3 Bubbler Pad	78
Senninger Magnum Weight Slip	78
Senninger Magnum Weight Threaded (for i-Wob)	78
Senninger UP3 Nozzles	79
Senninger UP3 Dual Nozzle Carrier	79
REGULATORS	80
Senninger PSR (Pivot Special) Regulators	80
GAUGES	80
Senninger Drop Pressure Gauge	80
HOSE, GOOSENECKS & FITTINGS	80
Senninger Poly Nipples	80
Senninger Poly Hose Tails	80
NPT Threaded Plug	81
Hose Clamps	81
Knipex Clamp Crimping Tool	81
Senninger Dropper Hose	82
Senninger Gooseneck 180 Degree Single	82
Senninger Gooseneck 125 Degree Single	82
Senninger Gooseneck 125 Degree Double	82
Senninger Truss Rod Slings	83
END SPRAYS	83
Senninger End Spray	83



IRRICO 
YOUR GLOBAL IRRIGATION PARTNER

IRRICO®

GEARBOXES

IRRICO® 740L & 740V Gearboxes

CODE	DESCRIPTION
GB74050L	IRRICO 740L 50:1 Gearbox
GB74052V	IRRICO 740V 52:1 Gearbox

Product Details

- Large input bearings and reinforced housing
- 2.25" diameter steel output shaft
- High strength cast iron bolt-on end caps
- Top oil fill



IRRICO® 760L & 760V Gearboxes

CODE	DESCRIPTION
GB76050L	IRRICO 760L Heavy Duty 50:1 Gearbox
GB76052V	IRRICO 760V Heavy Duty 52:1 Gearbox

Product Details

- Larger diameter bull gear than the standard 740 series
- Handles 20% higher torque
- 2.5" output shaft to accommodate more overhung load



IRRICO® Towable Gearboxes

CODE	DESCRIPTION
GBT50L	IRRICO 50:1 L Towable Gearbox
GBT52V	IRRICO 52:1 V Towable Gearbox

Product Details

- 2.25" diameter steel output shaft
- 50:1 or 52:1 gear ratios
- Dual input seals and a triple lip output seal
- Disengageable worm gear for towing
- Full cycle external expansion chamber with stainless steel cover
- External seal protectors for input and output seals
- Top oil fill plug
- Filled with extreme pressure gear oil
- Dual ended input shaft with a hub cap for the unused end
- Extra-long carriage bolts allow use with reinforced rims
- Positive wheel register



Gearboxes cont.

IRRICO® 68:1 Planetary Gearbox

CODE	DESCRIPTION
GBP68	Irrico 68:1 Planetary Gearbox

Product Details

- T-L Planetary Gearbox replacement unit
- Suitable for T-L 9 wheel stud hydrostatic drive machines
- Quick input shaft disengagement for easy use on towable machines
- 68:1 gear ratio
- Filled with lithium grease



CENTRE DRIVES

IRRICO® Centre Drives

CODE	DESCRIPTION
CD20150	IRRICO Centre Drive 20:1 1.5HP
CD25150	IRRICO Centre Drive 25:1 1.5HP
CD30150	IRRICO Centre Drive 30:1 1.5HP
CD40075	IRRICO Centre Drive 40:1 0.75HP
CD50075	IRRICO Centre Drive 50:1 0.75HP
CD60075	IRRICO Centre Drive 60:1 0.75HP

Product Details

- Aluminium gear case and motor housing
- Class F insulation
- Multi-bolt mounting pattern fits (3 3/8" x 6 3/8"), (4 3/4" x 7 1/4") and (5" x 6") bolt patterns
- Voltage 460V 60Hz, 380V 50Hz
- Helical gear design, high strength steel shafting for long life and dependability
- Thermally protected with automatic reset
- All gears are heat treated
- Shipped with gear oil



COUPLERS

IRRICO® Standard Coupler

CODE	DESCRIPTION
ISC	7/8" x 1" Standard Coupler

Product Details

- Economy Drive Line Coupler
- Designed to protect critical drive train components in an overload condition
- Alignment rod holds insert in place and maintains alignment under extreme loads
- Urethane insert is an environmentally stable material
- Grooved insert option converts any coupler for a towable application
- Bolts create unique anti-rotation feature that allows for fast single wrench assembly
- Curved insert pressure pads compensate for out of line conditions



SC3 Universal Driveline Coupler

CODE	DESCRIPTION
SC3	SC3 Universal Drive Line Coupler

Product Details

- Premium Drive Line Coupler
- EZ Installation - Fits all brands of center pivots and laterals with 1" round and 3/4" and 7/8" square shafts
- Shock reducing, UV protected, thermoplastic polyurethane drive puck
- Comes preassembled with high strength, square shaft saddle
- EZ Installation with one wrench tightening 3 bolts for complete assembly
- High quality degassed diecast aluminum design that fits under most drive line safety covers



Black Max Universal Driveline Coupler

CODE	DESCRIPTION
BMC	Black Max Drive Line Coupler

Product Details

- The Market Leading Drive Line Coupler
- The die-cast anodized aluminium body coupled with an In-Flex Disc adds the strength and flexibility that is ideal for today's mechanized irrigation systems with large tyres, 4x4 corner machines and corner-steering gear boxes
- In-Flex™ thermoplastic disc is 30% more flexible than the competitive brands
- In-Flex™ technology keeps gear boxes and centre drives running longer
- Pre-assembled for easy one-size wrench installation
- Universal design - Fits 3/4", 7/8" and 1" square shafts
- Fits under most driveline covers for maximum safety
- 5 year disc warranty



WHEELS & TYRES

IRRICO® Wheels, Tyres & Tubes

CODE	DESCRIPTION
1492410ML	14.9 x 24" Wheel, Tyre & Tube (Irrico-L Offset)
1492412MV	14.9 x 24" Wheel, Tyre & Tube (Irrico-V Offset)
1692415ML	16.9 x 24" Wheel, Tyre & Tube (Irrico-L Offset)
1692415MV	16.9 x 24" Wheel, Tyre & Tube (Irrico-V Offset)
1123810M	11.2 x 38" Wheel, Tyre & Tube
1424T	Tube to Suit 14.9 x 24"
1624T	Tube to Suit 16.9 x 24"



BOOSTER PUMPS IRRICO®

2HP & 5HP Booster Pumps

CODE	
BP2HP-I	2.5" Suction and 2" Discharge
BP5HP-I	2.5" Suction and 2" Discharge

Product Details

- Assembled in Australia
- High grade copper windings and insulation for longer motor life
- Double layer powder coated motor housing and fan shroud provide the highest available corrosion resistance
- Cast iron volute with threaded connections: 2.5" suction and 2" discharge
- Stainless Steel impeller
- Stator & volute separated by silicon gaskets / sleeves & seals to avoid galvanic corrosion

2-HP Booster Pump - BP2HP-I

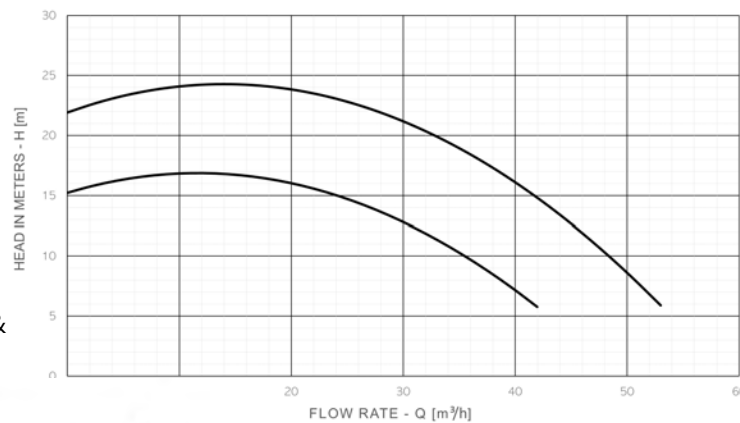

5-HP Booster Pump - BP5HP-I

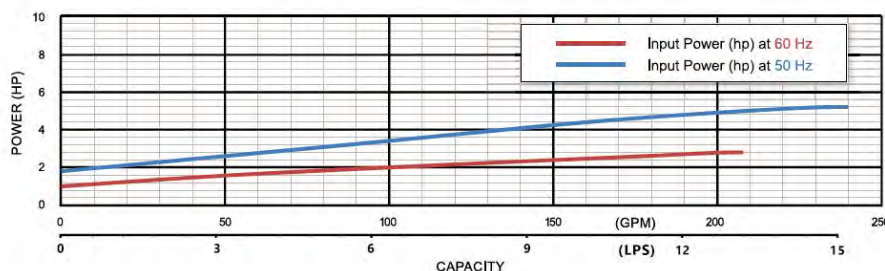
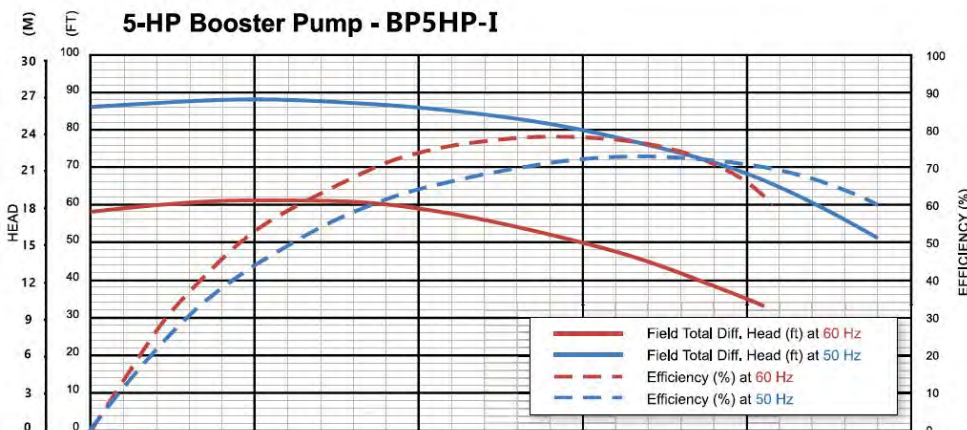

BP2HP-I



BP5HP-I



TOWER BOXES & PARTS

Irrico-L Intermediate Tower Box

CODE	DESCRIPTION
LSITB	Irrico-L Intermediate Tower Box

Product Details

- 400v 25 Amp contactor
- 110v coil
- Premium cover with stainless steel latches
- All bolts, mounting plate & return spring are stainless steel for long life

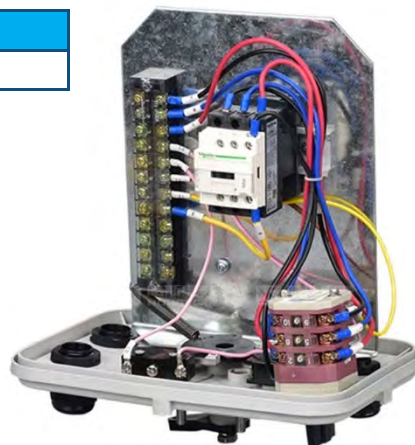

Irrico-L Stall Tower Box

CODE	DESCRIPTION
LSSTB	Irrico-L Stall Tower Box

Product Details

- 400v 25 Amp contactor
- 110v coil
- Premium cover with stainless steel latches
- All bolts, mounting plate & return spring are stainless steel for long life



Irrico-L Last Tower Box

CODE	DESCRIPTION
LSLTB	Irrico-L Last Tower Box

Product Details

- 400v 25 Amp contactor
- 110v coil
- Premium cover with stainless steel latches
- All bolts and mounting plate are stainless steel for long life



Irrico-L Booster Pump Tower Box

CODE	DESCRIPTION
LSBPTB	Irrico-L Booster Pump Tower Box

Product Details

- 400v 25 Amp contactors
- 110v coils
- Premium cover with stainless steel latches
- All bolts and mounting plate are stainless steel for long life

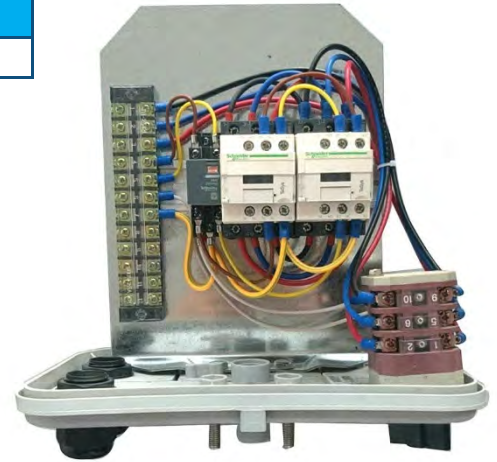

Irrico-L Tower Box Base

CODE	DESCRIPTION
8221B	Tower Box Base (Irrico-L)

Product Details

- Premium quality bare tower box replacement base.



Irrico-L Tower Box Cover

CODE	DESCRIPTION
8221C	Irrico-L Tower Box Cover

Product Details

- Replacement tower box cover with stainless latches



Irrico-L Cam

CODE	DESCRIPTION
LSTBC	Irrico-L Tower Box Cam

Product Details

- Replacement Irrico-L tower box cam



Irrico-L Cam Arm

CODE	DESCRIPTION
LSTBCA	Irrico-L Cam Arm

Product Details

- Solid, quality replacement cam arm



Irrico-L Cam Arm Spring

CODE	DESCRIPTION
LSTBCAS	Irrico-L Cam Arm Spring

Product Details

- Galvanised cam arm spring



Irrico-L Cam Arm Bolt, Nut & Washer

CODE	DESCRIPTION
LSCABNW	Bolt, Nut and Washer to suit Cam and Arm

Product Details

- Stainless steel bolt, nut & washer



Irrico-L Stainless Linkage Kit

CODE	DESCRIPTION
LSTBSLK	Adjustable Linkage Kit Complete

Product Details

- All stainless steel components, complete
- Includes 313205, 604702 and 644000

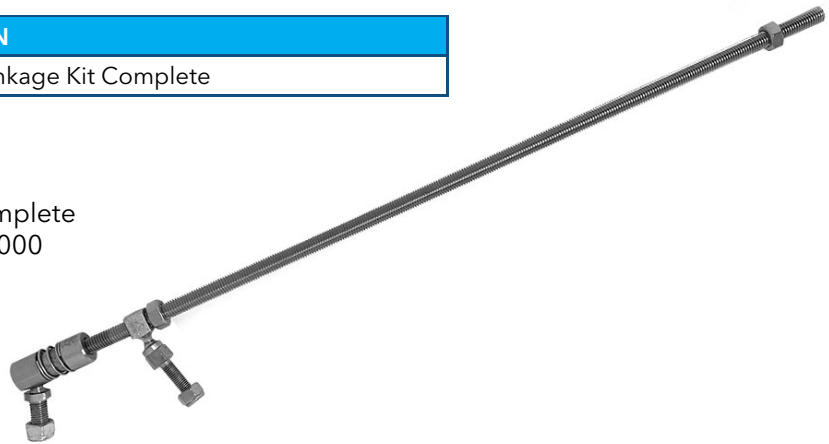

Irrico-L Stainless Linkage Rod

CODE	DESCRIPTION
313205	Linkage Rod SS $5/16"$ - 24 x 16"

Product Details

- Stainless steel linkage rod with 2 nuts



Irrico-L Stainless Quick Disconnect

CODE	DESCRIPTION
604702	Ball Joint Quick Disconnect

Product Details

- Stainless steel quick disconnect
- Suits standard stainless rod kit

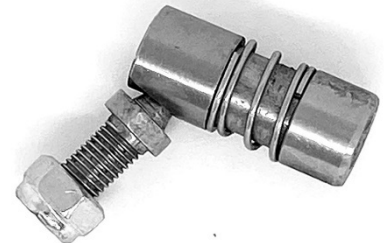

Irrico-L Stainless Ball Swivel Joint Adjuster

CODE	DESCRIPTION
644000	Ball Swivel Joint Adjuster

Product Details

- Stainless steel swivel joint and stainless nyloc nut
- Suits standard stainless rod kit

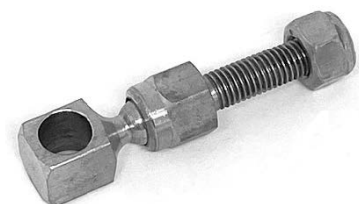

STRUCTURAL COMPONENTS

Irrico-L Centre Point

CODE	DESCRIPTION
LS6CP	Irrico-L Centre Point with 6 5/8" Top Elbow
LS8CP	Irrico-L Centre Point with 8" Top Elbow

Product Details

- All parts and components for a centre point from inlet elbow to top elbow
- Excludes control panel (pg. 55), mounting hardware (pg. 21) and collector ring (pg. 48)
- Excludes anchor system (pg. 20)



Irrico-L Pivot Elbow

CODE	DESCRIPTION
309203-6	Irrico-L Heavy Duty Pivot Elbow 6 5/8"
309203-6SS	Irrico-L Heavy Duty Pivot Elbow 6 5/8" Stainless Steel
309203-8	Irrico-L Heavy Duty Pivot Elbow 8"
309203-8SS	Irrico-L Heavy Duty Pivot Elbow 8"Stainless Steel
309203-JT	J Tube Conversion Kit for Irrico-L Centre Point

Product Details

- Galvanised Irrico-L centre point top elbow
- 309203-JT includes elbow, riser and J tube. Allows for a simple encoder conversion via a Irrico-V collector ring and encoder on a Irrico-L pivot



309203-6
309203-6SS
309203-8
309203-8SS

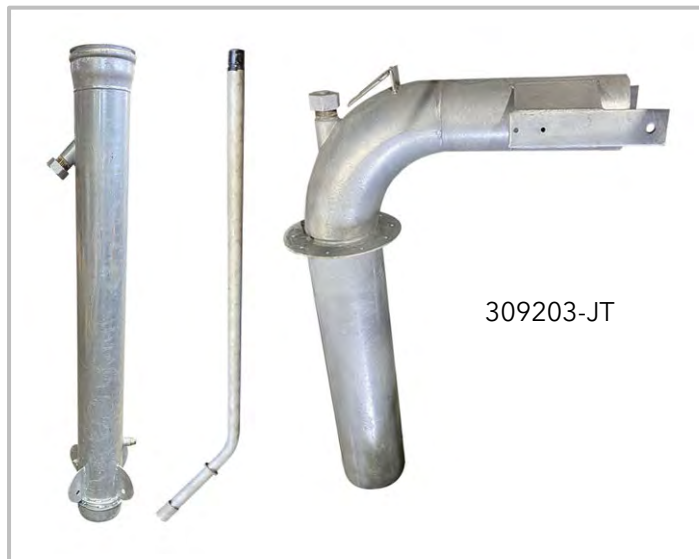

309203-JT

Irrico-L Pivot Head

CODE	DESCRIPTION
300301	Heavy Duty Pivot Head

Product Details

- Galvanised heavy duty pivot point head frame



Irrico-L Pivot Riser Pipe

CODE	DESCRIPTION
300707	Pivot Riser Pipe
300707SS	Pivot Riser Pipe Stainless Steel

Product Details

- 8" Irrico-L galvanised replacement centre point pivot riser pipe



Irrico-L Bottom Inlet Elbow

CODE	DESCRIPTION
6622492	Irrico-L Inlet Elbow 8" with Pierce Ends
6622492-4	Irrico-L Inlet Elbow with 4" Table D Flange
6622492-6	Irrico-L Inlet Elbow with 6" Table D Flange
6622492-8	Irrico-L Inlet Elbow with 8" Table D Flange

(While Stocks Last)

(While Stocks Last)



Flange Galvanised Pipe Reducer

CODE	DESCRIPTION
RED8X4	Galvanised HD Pipe Reducer 8" to 4" ANSI/Table D
RED8X6	Galvanised HD Pipe Reducer 8" to 6" ANSI/Table D

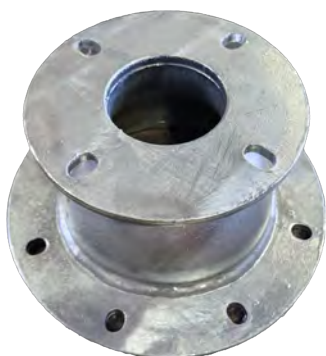

Irrico-L Centre Point Riser Straps

CODE	DESCRIPTION
400630	Stabilizer Strap for Pivot Centre Point

Product Details

- Sold individually. 4 Required per centre point

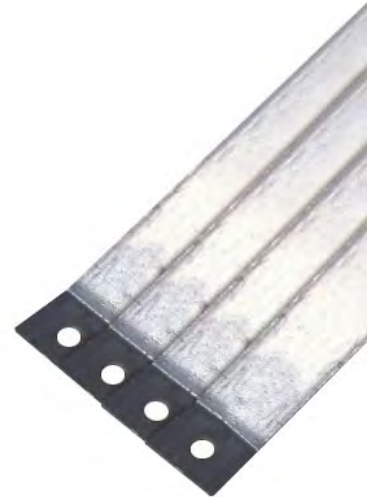

Irrico-L Heavy Duty Centre Point Legs & Tie Angles

CODE	DESCRIPTION
346007	Heavy Duty Centre Point Leg Angle
308304	Tower Top Tie Angle
311100	Tower 2nd to Top Tie Angle
308106	Tower 2nd to Bottom Tie Angle
369397	Tower Bottom Tie Angle

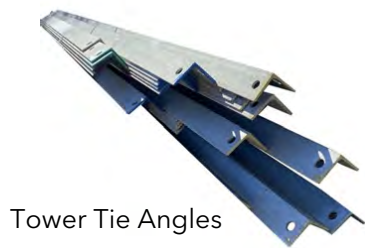

Tower Tie Angles

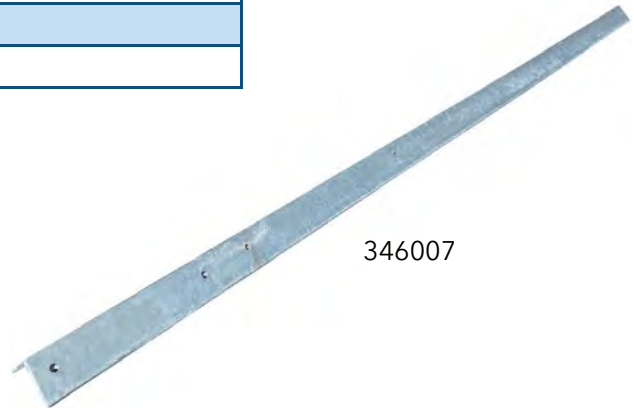

346007

Irrico-L Non-Tow Pivot Anchor Kit

CODE	DESCRIPTION
348490	Non-Tow Anchor Kit

Product Details

- Kit contains four feet with square galvanised washers



Irrico-L Non-Tow Pivot Anchor Bolt

CODE	DESCRIPTION
347765	Non-Tow Anchor Bolt

Product Details

- Black steel rod with nyloc nut
- Sold individually. 4 Required per centre point

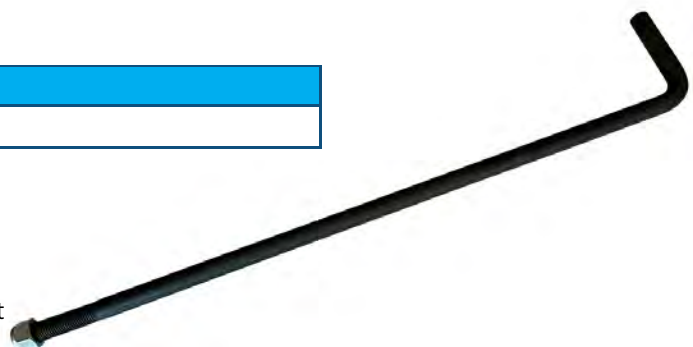

Irrico-L Upper Panel Mount Bracket

CODE	DESCRIPTION
119516	Galvanised Centre Panel Upper Mounting Bracket

Product Details

- Suits mounting of Irrico-L main panels
- Brackets sold separately (2 required per panel)



Irrico-L Lower Panel Mount Bracket

CODE	DESCRIPTION
119515	Galvanised Centre Panel Lower Mounting Bracket

Product Details

- Suits mounting of Irrico-L main panels
- Brackets sold separately (2 required per panel)



Irrico-L Tower Box Mounting Brackets

CODE	DESCRIPTION
367607	Tower Box Mounting Bracket
40900	Booster Pump Tower Box Mounting Bracket

Product Details

- Galvanised mounting brackets to suit Irrico-L tower boxes



367607



40900

Irrico-L Pivot End Joint

CODE	DESCRIPTION
1100627	6 5/8" Pivot Joint
306803	8" Pivot Joint

Product Details

- Fully galvanised pivot end joint



Irrico-L Tower End Joint

CODE	DESCRIPTION
306928	6 5/8" Tower Joint Galvanised
306928P	6 5/8" Tower Joint Poly Lined
1175808	8" Tower Joint Galvanised
1175808P	8" Tower Joint Poly Lined

Product Details

- Irrico-L replacement tower end joints, Galv or Poly Lined



Irrico-L Reducing Tower Joint

CODE	DESCRIPTION
306951	Joint from 6 5/8" to 5 9/16"
306951P	Joint from 6 5/8" to 5 9/16" Poly Lined
306852	Joint from 8" to 6 5/8"
306852P	Joint from 8" to 6 5/8" Poly Lined

Product Details

- Irrico-L replacement reducing tower end joints, Galv or Poly Lined



Irrico-L Last Tower Joint

CODE	DESCRIPTION
1154483	6 5/8" Centre Pivot Last Tower Joint
1154483SS	6 5/8" Centre Pivot Last Tower Joint Stainless Steel

Product Details

- Irrico-L galvanised last tower joint bare, no sand trap



Irrico-L Alignment Ring

CODE	DESCRIPTION
467589	6 5/8" Alignment Ring
468140	8" Alignment Ring

Product Details

- Irrico-L galvanised alignment ring



Irrico-L 61m Span Spacer Flange

CODE	DESCRIPTION
1137082	6 5/8" Alignment Ring

Product Details

- Irrico-L galvanised 61m span spacer flange
- Used to improve shape of the 61m spans



Irrico-L Span Pipes

CODE	DESCRIPTION
381988	22' Half Span 4"
113650	22' Half Span 5 9/16"
113648	22' Half Span 6 5/8"
113654	22' Half Span 8"

Product Details

- 22' span half pipes with 3/4" FNPT outlets at 90" spacings
- Email or call for complete span pricing



Irrico-L Overhang Kits

CODE	DESCRIPTION
135022	22' Overhang
135044	44' Overhang
135066	66' Overhang
135088	88' Overhang

Product Details

- Overhang kit to suit Irrico-L machines
- Kit contains full overhang structure, cables, angles, brackets, gaskets, end plate & bolt sets
- Email or call for pricing on individual parts

Irrico-L Sand Trap Kit

CODE	DESCRIPTION
347278	Last Tower Joint Sand Trap

Product Details

- Galvanised replacement sand trap including O-ring, clamp and plug



Irrico-L End of Machine Flange Plate

CODE	DESCRIPTION
4008532	Flange with 2" NPT Socket

Product Details

- Galvanised end of machine flange plate to suit 5 9/16" or 4" pipes.
- Plug sold separately



Irrico-L 8" Weld On Coupler (Black)

CODE	DESCRIPTION
6614614	Black Weld on 8" Coupler

Product Details

- Black steel



Steel Coupler Clamps

CODE	DESCRIPTION
637124	5" Steel Coupler Clamp
660640	8" Steel Coupler Clamp



Bushes & Plugs

CODE	DESCRIPTION
63509	2 ½" NPT x 2" BSP bush
63510	2" Stainless Steel Plug to Suit 63509 Bush
GMP20	¾" NPT Plug



Nipple 2 ½" Male

CODE	DESCRIPTION
63600N	2 ½" SS NPT Nipple

Product Details

- Can be used to mount booster pumps if required



Irrico-L Drain Plugs

CODE	DESCRIPTION
635094	Drain, Multi-Pressure, 20-75 psi
344366	Quick Drain Kit

Product Details

- Multi pressure drain plug used in Irrico-L pivot end joints
- Quick drain kit used in Irrico-L first pivot end joint



635094



344366

Irrico-L Drive Tube

CODE	DESCRIPTION
307587	Non-Towable Drive Tube
307587T	Towable Drive Tube

Product Details

- Heavy duty fully galvanised
- Irrico-L drive tubes in both non-towable and towable versions



Irrico-L Drive Shaft

CODE	DESCRIPTION
407163	Drive Shaft 7/8" x 59 1/4"

Product Details

- Black Steel 7/8" square x 59 1/4" drive shafts to suit Irrico-L machines
- Sold individually. 2 Required per span



Irrico-L Drive Shaft Cover 1 1/2" x 54"

CODE	DESCRIPTION
644427	Protective Drive Shaft Cover

Product Details

- Helps protect the drive train from crop wrappage
- Polyethylene plastic withstands UV rays and is weatherproof



Irrico-L Drive Shaft Bell Washer

CODE	DESCRIPTION
64590	Rubber Drive Shaft Washer

Product Details

- Washer for centre pivot drive shaft (sold individually)



Irrico-L Drive Shaft Bell End 4 1/8"

CODE	DESCRIPTION
643783	Drive Shaft Bell End Cover 4 1/8"

Product Details

- Drive shaft coupler shield for centre pivot driveline system



Irrico-L Drive Shaft Bell End 5 1/4"

CODE	DESCRIPTION
635896	Drive Shaft Bell End Cover 5 1/4"

Product Details

- Drive shaft coupler shield for centre pivot driveline system



Worm Drive Hose Clamp

CODE	DESCRIPTION
SMP2A	Worm Drive Hose Clamp for Drive Shaft Bell

Product Details

- Stainless steel clamp



Irrico-L Tie Rod

CODE	DESCRIPTION
1169283	Span Tie Rod 7/8" x 21' 9 1/4"

Product Details

- Hot dip galvanised span tie rod



Irrico-L Tie Rod Brackets

CODE	DESCRIPTION
139950	Irrico-L Tie Rod Bracket (large)
1399960	Irrico-L Tie Rod Bracket (small)

Product Details

- Galvanised brackets for tie rods



139950

1399960

Irrico-L Tower Tie Angle Kit

CODE	DESCRIPTION
1364600	Galvanised Standard Profile Tower Tie Kit



Irrico-L Truss Angle Plate 6 5/8" & 8"

CODE	DESCRIPTION
304980	Plate Truss Angle 6 5/8"
305144	Plate Truss Angle 8"

Product Details

- Galvanised plate



Irrico-L Truss Angle Span Packs

CODE	DESCRIPTION
367326	Truss Bundle for 135' (41.13m) Span
367334	Truss Bundle for 157' (47.83m) Span
367347	Truss Bundle for 179' (54.53m) Span
367359	Truss Bundle for 201' (61.26m) Span

Product Details

- Complete galvanised span truss angle packs



Irrico-L Individual Truss Angle Sets

CODE	DESCRIPTION
LSTAS1	Truss Angle Set #1 (4 x Brace & 1 x Tie Angle)
LSTAS2	Truss Angle Set #2 (4 x Brace & 1 x Tie Angle)
LSTAS3	Truss Angle Set #3 (4 x Brace & 1 x Tie Angle)
LSTAS4	Truss Angle Set #4 (4 x Brace & 1 x Tie Angle)

201' (61.26m) 9 Pipe Span

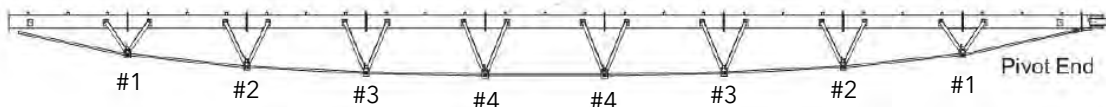

179' (54.53m) 8 Pipe Span

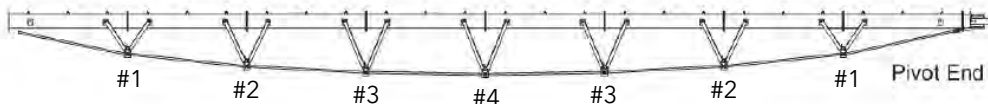

157' (47.83m) 7 Pipe Span

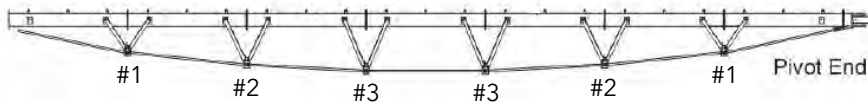

135' (41.13m) 6 Pipe Span

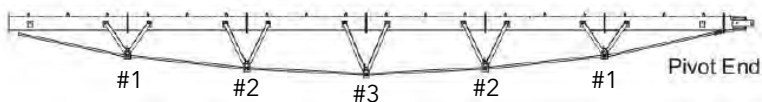

Irrico-L Stabilizer Angles

CODE	DESCRIPTION
367433	Galvanised Stabilizer Angles

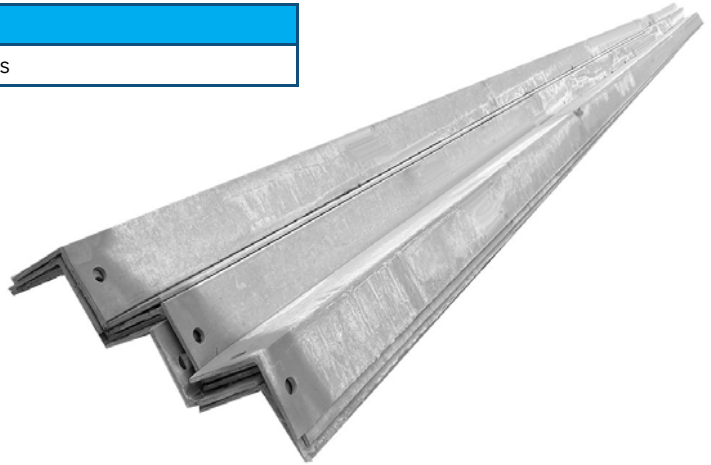

Irrico-L Stabilizer Ties

CODE	DESCRIPTION
307603	Left & Right Tie Plates for Stabilizer Angles

Product Details

- Left & Right hand galvanised tie plates
- Sold as a pair



Irrico-L Span Tower Leg 11'

CODE	DESCRIPTION
367417	Galvanised Tower Leg

Product Details

- Galvanised standard profile tower leg

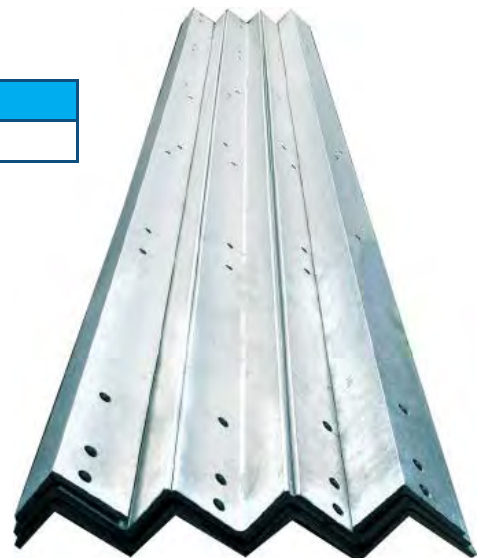

Irrico-L Upper Leg Clamp

CODE	DESCRIPTION
367516	Tower Leg Clamp (Upper) 6 5/8"
367557	Tower Leg Clamp (Upper) 8"



Product Details

- Galvanised upper leg clamp section

Irrico-L Lower Leg Clamp

CODE	DESCRIPTION
367524	Tower Leg Clamp (Lower) 6 5/8"
367565	Tower Leg Clamp (Lower) 8"



Product Details

- Galvanised lower leg clamp section

Irrico-L Span Bolt Kit

CODE	DESCRIPTION
300962	6 5/8" Bolt Kit
300962-8	8" Bolt Kit

Product Details

- Quantity suitable for 54m spans



End of Field Switch Bracket & Switch Kit

CODE	DESCRIPTION
LSLSWB	Limit Switch Mounting Bracket
LSLSWKIT	Limit Switch Kit (2 Switches)

Product Details

- Galvanised Bracket Irrico-L
- Limit Switch Kit



Goosenecks Galvanised 3/4" 180 degree

CODE	DESCRIPTION
634121MB	3/4" Galvanised Gooseneck - Male/Barb
634121MF	3/4" Galvanised Gooseneck - Male/Female

Product Details

- Threaded galvanised 180 degree pipe gooseneck.



Poly Dropper Weight

CODE	DESCRIPTION
116970	2lb Poly Weight for Dropper Hose

Product Details

- Over hose poly weight for dropper hoses



Irrico-V Intermediate Tower Box

CODE	DESCRIPTION
VSITB	Irrico-V Intermediate Tower Box Stainless Steel

Product Details

- Stainless steel construction
- 400v 25 Amp contactor
- 110v coil
- Premium cover with stainless latches

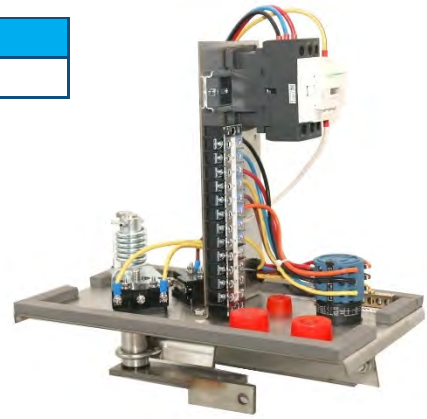

Irrico-V Stall Tower Box

CODE	DESCRIPTION
VSSTB	Irrico-V Stall Tower Box Stainless Steel

Product Details

- Stainless steel construction
- 400v 25 Amp contactor
- 110v coil
- Premium cover with stainless latches

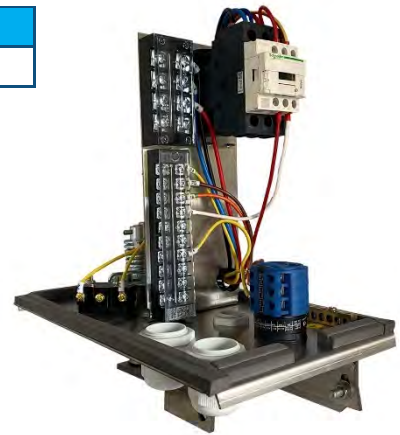

Irrico-V Last Tower Box

CODE	DESCRIPTION
VSLTB	Irrico-V Last Tower Box Stainless Steel

Product Details

- Stainless steel construction
- 400v 25 Amp contactor
- 110v coil
- Premium cover with stainless latches

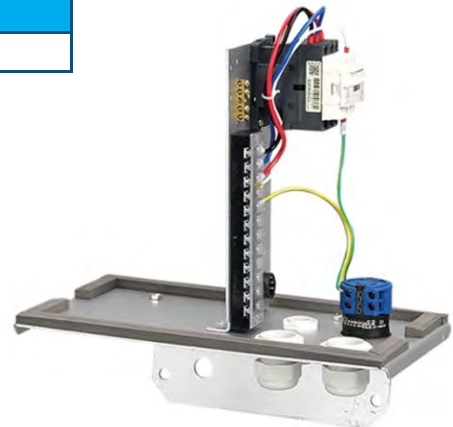

Irrico-V Auto Reverse Tower Box

CODE	DESCRIPTION
VSARTB	Irrico-V Auto Reverse Tower Box Stainless Steel

Product Details

- Stainless steel construction
- Premium cover with stainless latches

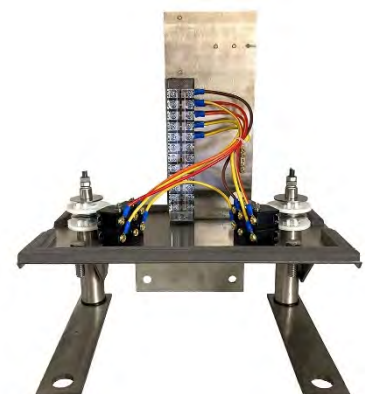

Irrico-V Booster Pump Tower Box

CODE	DESCRIPTION
VSBPTB	Irrico-V Booster Pump Tower Box Stainless Steel

Product Details

- Stainless steel construction
- 400v 25 Amp contactors
- 110v coil
- Premium cover with stainless latches

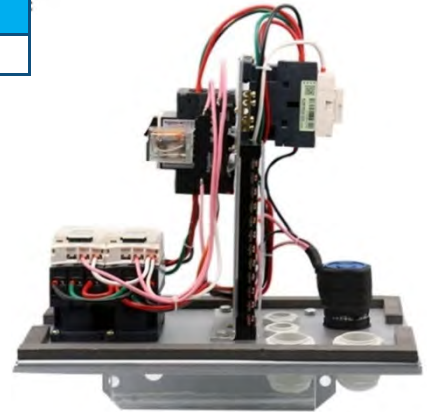

Irrico-V Auto Stop Tower Box

CODE	DESCRIPTION
VSASTB	Irrico-V Auto Stop Tower Box Stainless Steel

Product Details

- Stainless steel construction
- Premium cover with stainless latches

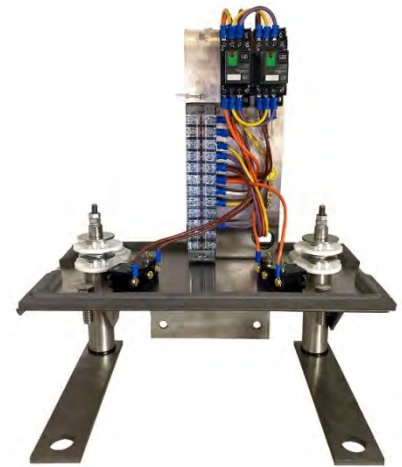

Irrico-V Tower Box Lid

CODE	DESCRIPTION
VSTBL	Irrico-V Tower Box Lid

Product Details

- Replacement tower box lid with stainless latches



Irrico-V Tower Box Control Arm & Keeper Plate

CODE	DESCRIPTION
1701295	Irrico-V Tower Box Control Arm
1700156	Irrico-V Lower Keeper Plate
VSTBBK	Irrico-V Tower Box Control Arm and Mount Bolts



VSTBBK



1701295



1700156

Irrico-V Centre Point

CODE	DESCRIPTION
VSBCPC	Irrico-V Series Centre Point

Product Details

- All parts and components for a Centre Point from inlet elbow to top elbow
- Excludes control panel (pg. 55), mounting hardware (pg. 39) and collector ring (pg. 48).
- Excludes anchor system (pg. 36)



Irrico-V Pivot Upper Elbow Swivel Assembly

CODE	DESCRIPTION
9361392	Irrico-V Heavy Duty Pivot Elbow 8 5/8"



Irrico-V Riser Pipe Coupling Clamp and Bearing

CODE	DESCRIPTION
205073	8 5/8" Riser Pipe Coupling Clamp with Seal
9361575	8 5/8" Riser Pipe Coupling Bearing



Irrico-V Pivot Head

CODE	DESCRIPTION
9361394	8 5/8" Pivot Head Bearing



Irrico-V Riser Pipe

CODE	DESCRIPTION
9361365	Riser Pipe 8 5/8"

Product Details

- Galvanised riser pipe with Pierce coupling



Irrico-V Bottom Inlet Elbow

CODE	DESCRIPTION
9361956	8 5/8" Flanged Inlet Pipe

Product Details

- Galvanised Irrico-V inlet pipe



Irrico-V J-Tube & V-Packing

CODE	DESCRIPTION
1114099	Irrico-V J-Tube
254004	V-Packing Set

Product Details

- Stainless Steel J-Tube
- V-Packing set contains 5 rings
- Two sets required per J-Tube



Irrico-V Pivot Point Heavy Duty Legs & Angles

CODE	DESCRIPTION
9361386	Pivot Point Heavy Duty Leg Angle
9361548	Upper Pivot Point Brace Angle
9361385	Middle Pivot Point Brace Angle
9361383	Bottom Pivot Point Brace Angle

Product Details

- Angles sold separately
- 4 of each angle are required for a complete set

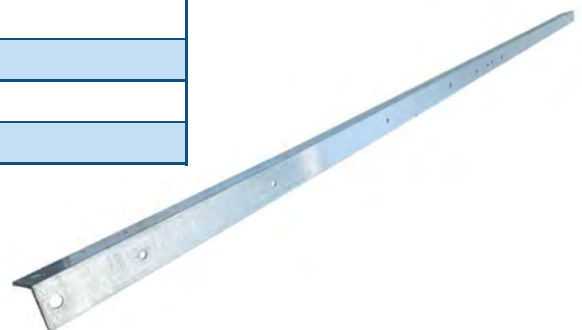

Irrico-V Non-Towable Pivot Foot

CODE	DESCRIPTION
1704017	Galvanised Pivot Foot

- Galvanised heavy duty pivot foot
- Sold individually (4 required per centre point)



Irrico-V Pivot Anchor Bolts

CODE	DESCRIPTION
1702191	Anchor Bolt M22

Product Details

- Galvanised anchor bolt, nut & washer
- Sold individually (4 required per centre point)



Irrico-V Hinge Joint

CODE	DESCRIPTION
9360103	Hinge Half
112037	¾" x 2" Pin
142021	M20 Flat Washer
151010	⅛" x 1 ½" Stainless Steel Cotter Pin
9360103C	Hinge Joint Complete (2 halves with pins)

Product Details

- Galvanised hinge piece
- 9360103C does not include rubber boot hose or clamps. Order separately, see p.45 for part numbers.

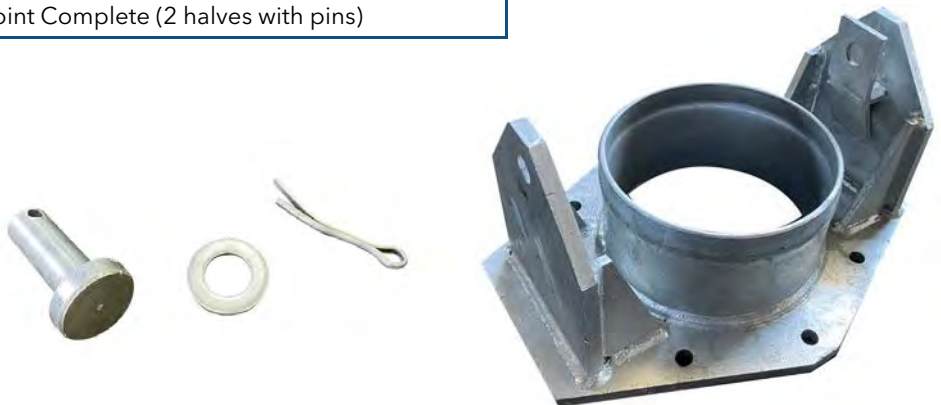

Irrico-V First Pipe

CODE	DESCRIPTION
9361464	First Pipe 8 5/8" to 6 5/8" Flange

Product Details

- V series compatible



Irrico-V Swivel Short Pipe

CODE	DESCRIPTION
9360675	6 5/8" Swivel Short Pipe

Product Details

- V series compatible



Irrico-V Fixed Stub Pipe

CODE	DESCRIPTION
9360677	6 5/8" Fixed Stub Pipe

Product Details

- V series compatible



Irrico-V Last Stub Pipe

CODE	DESCRIPTION
9360676	6 5/8" Last Stub Pipe

Product Details

- V series compatible



Irrico-V End Plates

CODE	DESCRIPTION
1800036	6 5/8" End Plate with 2" Nipple
1313003	6 5/8" End Plate 2" Mount for End Gun Mounting
246046	2" Cap for End Plate



Product Details

- Galvanised end plates
- 2" cap not supplied with 1800036, order separately



Irrico-V Span Pipes

CODE	DESCRIPTION
2060304	19' x 6 5/8" Span Pipe - 3 Outlet 1.9m Spacing
2060404	19' x 8 5/8" Span Pipe - 3 Outlet 1.9m Spacing
2060104	38' x 6 5/8" Span Pipe - 6 Outlet 1.9m Spacing
2060204	38' x 8 5/8" Span Pipe - 6 Outlet 1.9m Spacing



Product Details

- Galvanised span pipes to suit Irrico-V machines
- Call for complete span pricing

Irrico-V Overhang Kits & Angles

CODE	DESCRIPTION
2317002	2.75m Overhang
2317005	5.52m Overhang
2317008	8.35m Overhang
2317011	11.03m Overhang
2317016	16.46m Overhang
2317025	24.99m Overhang

Product Details

- Overhang kit to suit Irrico-V machines
- Kit contains full overhang structure, cables, angles, brackets, gaskets, end plate & bolt sets
- Call for pricing on individual parts
- Cable support angles and brackets listed below

CODE	DESCRIPTION
1700982	Overhang Long Support Angle (2 required)
9360229	Upper Overhang Sign Support Angle
1701021	Lower Overhang Sign Support Angle
9363792	Overhang Trapezoid Plate
9361357	6 5/8" Cable Mounting Ear Bracket



9363792



9361357

Irrico-V Stabilizer Clamp

CODE	DESCRIPTION
1129001	6 5/8" Stabilizer Clamp Top and Bottom Halves

Product Details

- Galvanised clamp to suit 6 5/8" pipes
- 4" in width



Irrico-V Span Tower Leg & Brace Angles

CODE	DESCRIPTION
9360828	Tower Leg Left Hand 3628 mm
9360827	Tower Leg Right Hand 3628 mm
1780327	Tower Upper Brace - Standard Profile
9360835	Tower Intermediate Brace - Standard Profile
9360834	Tower Lower Brace - Standard Profile

Product Details

- Tower Leg & Brace Angles - 2 of each required for a full set

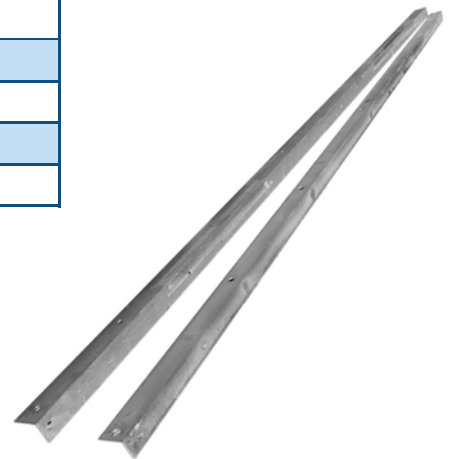

Irrico-V Main Panel Mount Angles

CODE	DESCRIPTION
1780273	Short Angles (x 4)
1780272	Long Angles (x 2)

Product Details

- Galvanised angles

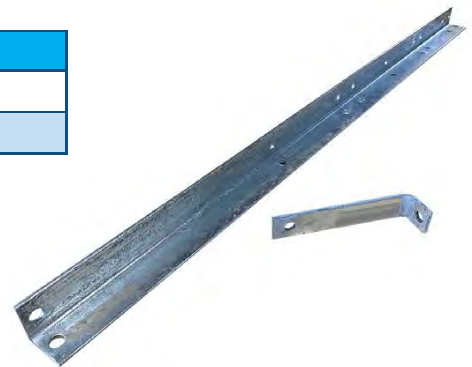

Irrico-V Drive Shaft

CODE	DESCRIPTION
361713	Drive Shaft 22mm x 1524mm

Product Details

- Sold individually, 2 required per span



Irrico-V Drive Shaft Shield Tube

CODE	DESCRIPTION
992715	Protective Drive Shaft Tubing

Product Details

- Helps protect the drive train from crop wrappage
- Polyethylene plastic withstands UV rays and is weatherproof
- Sold individually, 2 required per span



Irrico-V Drive Coupling Shield

CODE	DESCRIPTION
1206004	Drive Coupling Shield

Product Details

- Helps protect drive couplings from crop wrappage
- Polyethylene plastic withstands UV rays and is weatherproof
- Sold individually, 4 required per span



Irrico-V Trapezoid Gusset and Tower Reinforcing Plate

CODE	DESCRIPTION
9360068	Trapezoid Gusset
1780400	Drive Unit Reinforcing Plate



9360068



1780400

Product Details

- Galvanised gusset plate
- Galvanised drive unit reinforcing plate - bolts across top of span legs

Irrico-V Tower Support & Drive Unit Diagonal Pipes

CODE	DESCRIPTION
9360722	Tower Support Pipe Late Model
9360071	Tower Support Pipe Early Model
361138	Drive Unit Diagonal Pipe - Heavy Duty



Product Details

- Late Model Support Tube has Holes C-C 4820mm
- Early Model Support Tube has Holes C-C 4450mm
- Note: Galvanised Pipe not Tube

Irrico-V Tower Tie Brace Angle

CODE	DESCRIPTION
9360078	Tie Brace Angle

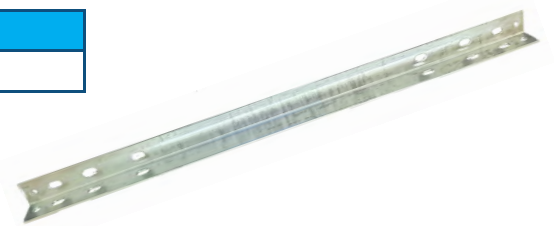

Product Details

- Used to Fasten Tower Support Pipes and Truss Rods Together at Tower End of Span

Irrico-V Tower Base Beam Non-Towable

CODE	DESCRIPTION
1780995	6 3/4" Base Beam Standard Profile

Product Details

- Galvanised tower base beam non-tow



Irrico-V Truss Angle Sets

CODE	DESCRIPTION
VSTAS3	Truss Angle Set "3"
VSTAS5	Truss Angle Set "5"
VSTAS6	Truss Angle Set "6"
VSTAS7	Truss Angle Set "7"
VSTAS8	Truss Angle Set "8"
VSTAS9	Truss Angle Set "9"
VSTAS10	Truss Angle Set "10"

Product Details

- Each set includes 4 diagonal and 1 spreader galvanised angles (Figure A)
- Choose the appropriate set or complete package from the span diagrams below

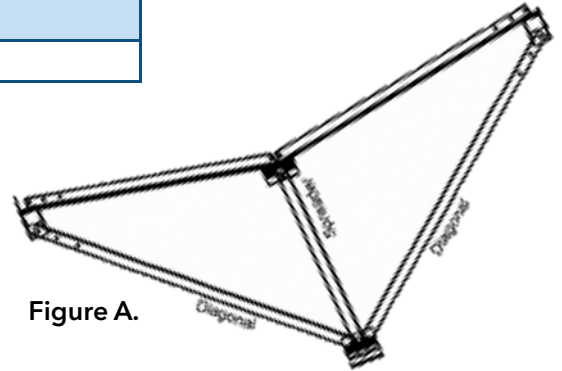
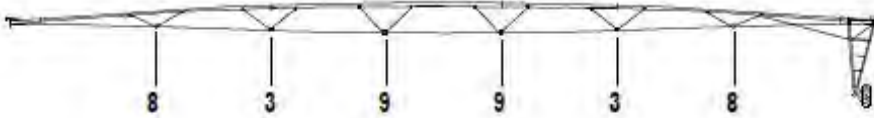

Figure A.

Location of Truss Angle Sets & Package Codes for Corresponding Spans

142.3' (43.37m) Span



Complete 6 Set Package for 43.37m Span: KA09283

161.2' (49.13m) Span

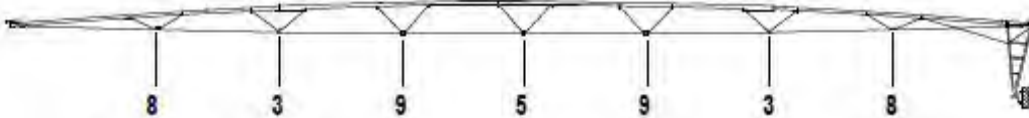

Complete 7 Set Package for 49.13m Span: KA09285

180' (54.86m) Span

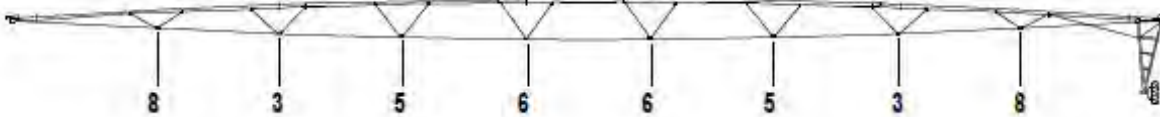

Complete 8 Set Package for 54.86m Span: KA09288

198.9' (60.63m) Span

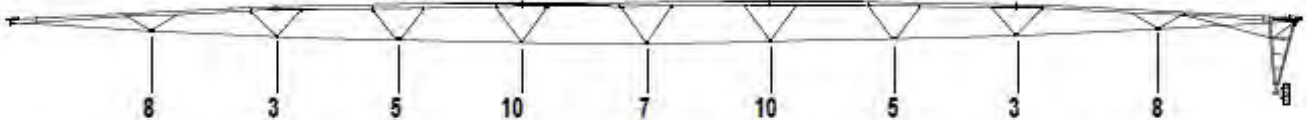

Complete 9 Set Package for 60.63m Span: KA09290

Irrico-V Truss Rod

CODE	DESCRIPTION
9360682	Intermediate Truss Rod - 20mm x 5697mm
9360683	Tower Truss Rod - 20mm x 6778mm
9360718	Tower Truss Rod - 22mm x 6778mm

Product Details

- Galvanised truss rod



Irrico-V Truss Rod Clamp Outer and Inner

CODE	DESCRIPTION
9360069	Truss Rod Outer Clamp
9360070	Truss Rod Inner Clamp



Irrico-V Hardware Kit

CODE	DESCRIPTION
1301003	54 x 6 5/8" Span Bolt Kit

Product Details

- 6 5/8" span bolt kit to suit 54m, 4½ pipe style spans



End Stops

CODE	DESCRIPTION
EOFSL	Irrico-L End Stop Kit
EOFSV	Irrico-V End Stop Kit

Product Details

- Includes tower mount hardware
- Includes 2 end of field barriers

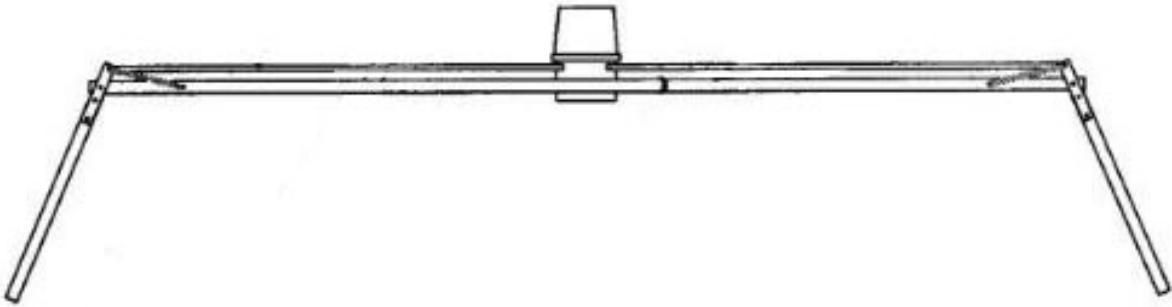

SPAN BOOT HOSE, CLAMPS & GASKETS

Irrico-L Couplers & Boots

CODE	DESCRIPTION
634906	Gasket Boot 5 9/16"
644906	Gasket Boot 6 5/8"
62087	Gasket Boot 8"
634914	Coupler Half 5 9/16" (pricing per pair)
644914	Coupler Half 6 5/8" (pricing per pair)
62100	Coupler Half 8" (pricing per pair)
SBBNK10	Bolt & nut kit to suit 5 9/16" & 6 5/8" couplers
SBBNK12	Bolt & nut kit to suit 8" coupler



Product Details

- Cast aluminium coupler halves sold as a pair
- Bolt & Nut kits ordered separately

Irrico-V Span Boot Hose

CODE	DESCRIPTION
7940-16	6 5/8" x 16" span boot hose
7944-10	8" x 10" universal hinge boot hose
7946-16	8 5/8" x 16" span boot



Product Details

- Reinforced rubber hose

Irrico-V Span Boot T-Bolt Clamps

CODE	DESCRIPTION
7852	6 5/8" - 175 clamp to suit 7940-16 boot hose
7873	8" - 214 clamp to suit 7944-10 boot hose
7876	8 5/8" - 227 clamp to suit 7946-16 boot hose

Product Details

- Stainless steel clamps to suit span boot hoses
- 7873 also used as Irrico-L Collector Ring Mounting Clamp



Irrico-L Style Span Pipe Gasket

CODE	DESCRIPTION
632851	5 ⁹ / ₁₆ " Pipe Gasket
644864	6 ⁵ / ₈ " Pipe Gasket
607952	8" Pipe Gasket

Product Details

- Medium density style plastic



Irrico-L Style Flange Gasket

CODE	DESCRIPTION
634436	4" Overhang Pipe Gasket

Product Details

- 4.5mm natural insertion rubber material



Irrico-L Riser Pipe Sealing Washers, Nuts and Bolts

CODE	DESCRIPTION
608208	Irrico-L Riser Pipe Sealing Washer
106024	M12 * 45mm 8.8 Set Screw
133005	M12 Flare Nut

Product Details

- Washers, Bolts and Nuts sold separately
- 3 of each required to make one full set



Triple Lip Gaskets

CODE	DESCRIPTION
6610505	5" Gasket
6610703	8" Gasket

Product Details

- Triple lip round back rubber gasket



Irrico-V Span Pipe Gasket

CODE	DESCRIPTION
991107	6 5/8" Pipe Gasket
994500	8 5/8" Pipe Gasket

Product Details

- Medium density style plastic



Irrico-V Flat Gaskets

CODE	DESCRIPTION
992211	6 5/8" Flat Gasket
996370	Combination 8" - 8 5/8" Flat Gasket

Product Details

- 4.5mm natural insertion rubber material
- 6 5/8" Flat Gasket used on Overhang Pipes
- Combination 8" - 8 5/8" Flat Gasket is used in the Flex Joint Assembly & on the Riser Pipe Entry



PIVOT STROBE LIGHT & CORN GLOBE

End of Pivot LED Strobe Light Kit

CODE	DESCRIPTION
31330	Red Strobe Light with Buzzer

Product Details

- 110vAC
- Visual and audible alert, when machine is moving
- Supplied with galv mounting plate & 5m power cable



Bright White LED Corn Globe

CODE	DESCRIPTION
CORN12	Multi Voltage E27 Pivot Light Replacement LED Globe

Product Details

- 85vAC - 265vAC, 12W
- Bright 6000K Light
- E27 Edison Screw
- IP64 - Long Life



PERCENTAGE TIMERS

Percentage Timers

CODE	DESCRIPTION
HE60PT	60 Second 120V Timer 50/60hz
RCDK004	Eagle 60 Second 120V Timer 50/60hz



COLLECTOR RINGS

Irrico-L Collector Ring

CODE	DESCRIPTION
LSCR11T	Irrico-L Collector Ring
308601	Collector Ring Shield Bracket

Product Details

- Standard Irrico-L 11 Track Collector Ring
- Collector Ring Shield Bracket (sold individually -3 Required)
- If Clamp is required use T-Bolt Clamp Code: 7873 Pg. 45



Irrico-V Collector Rings

CODE	DESCRIPTION
VSCR11TS	Irrico-V 11 Track Collector Ring (spring clip cover)
VSCR11T	Irrico-V 11 Track Collector Ring
VSCR13T	Irrico-V 13 Track Collector Ring

(While Stocks Last)

Product Details

- 11 or 13 track conductor rings
- 1" FNPT/BSP fitting
- Plastic lid
- Fitted with grease nipple
- VSCR11TS comes with 1-year warranty
- VSCR11TS stainless spring clips on cover latch
- VSCR11T & VSCR13T comes with 2-year warranty
- VSCR11T & VSCR13T features bolt down latches



VSCR11TS

VSCR11T/ VSCR13T

ELECTRICAL COMPONENT SPARES

Copper Earth Rod and Wire

CODE	DESCRIPTION
304352	Copper Earth Rod and Wire

Product Details

- Copper earth rod and cable



Galvanised Earth Rod

CODE	DESCRIPTION
314910	16mm Galv Rod x 1540mm Long

Product Details

- Galvanised earth rod

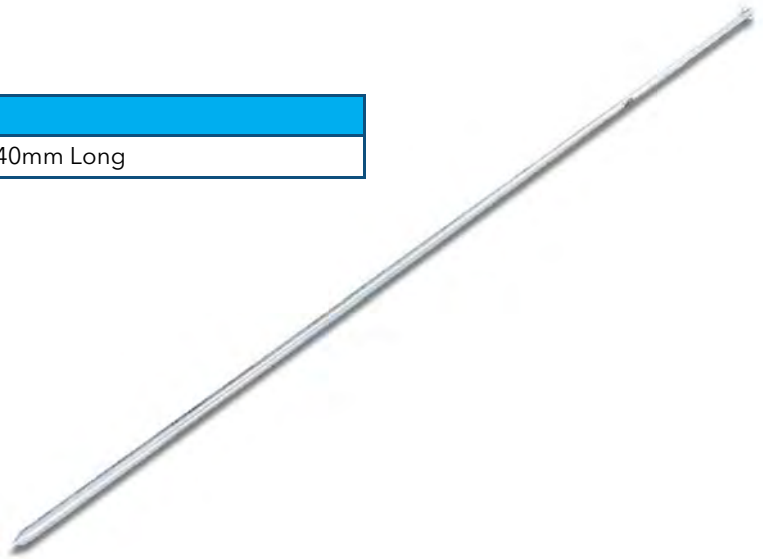

Lightning Arrestor

CODE	DESCRIPTION
349092	Delta Lightning Arrestor



Electrical Cable

CODE	DESCRIPTION
311902	Motor Lead - 4 #14 (per metre)
3119026	Motor Lead - 4 #14 (standard 6.5m lead)
369363	10 Core - 4 #12 6 #14 (per metre)
369370	10 Core - 4 #10 6 #14 (per metre)
412716	11 Core - 4 #12 7 #16 (per metre)
410714	11 Core - 4 #10 7 #14 (per metre)

Product Details

- PVC sheathed cable with aluminium shielding
- Order span cable as span length plus 2m
e.g. 54m span will need 56m of cable

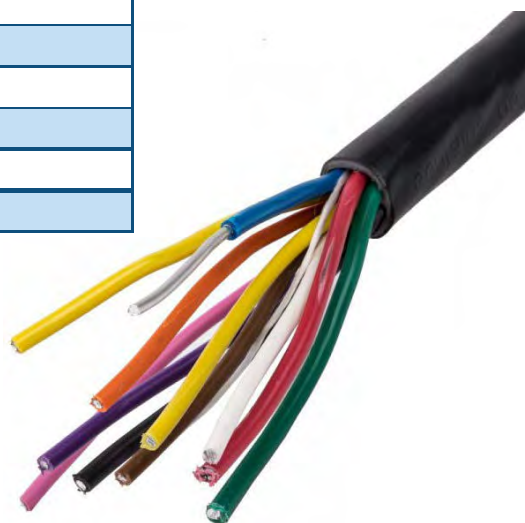

Speed Clips "S"

CODE	DESCRIPTION
625152	Speed Clips "S"

Product Details

- Motor lead cable clips



Span Cable Clips

CODE	DESCRIPTION
1163336	Span Pipe Cable Clip

Product Details

- Used to secure span cable to span pipe
- Fits 6 5/8" pipe
- Pricing is per clip



Irrico-L Micro Switch Long Arm

CODE	DESCRIPTION
LSMSLA	Irrico-L Micro Switch Long Arm

Product Details

- Microswitch to suit Irrico-L tower boxes



Irrico-V Micro Switch Short Arm

CODE	DESCRIPTION
VSMSSA	Irrico-V Micro Switch Short Arm

Product Details

- Microswitch to suit Irrico-V tower boxes
- Adjustable sensitivity



Pressure Switches

CODE	DESCRIPTION
BPS3-90	Barksdale E1S-H90 Pressure Switch

(While Stocks Last)

Product Details

- Barksdale pressure switch 3-90 PSI
- NO / NC wiring options



CODE	DESCRIPTION
D45X	Selectable Normally Open or Closed Pressure Switch

Product Details

- Rated Voltage: 110-240Vac
- Rated Current Maximum 4 Amps
- Working Pressure Adjustable 100 - 1000kPA
- Selectable Normally Open or Closed Circuit
- UL Listed



Pressure Transducers

CODE	DESCRIPTION
PT628	Pressure Transducer 4 - 20 mA
IRRPT	Pressure Transducer 0-5 V output

Product Details

- 0-10 bar pressure range
- -18°C and 79°C temperature range
- Power supply 10-30VDC
- Output 4-20mA or 0-5Vdc
- IRRPT suits B-hyve AG installations
- 1/4" BSP Threads



Irrico-L Collector Ring Brushes

CODE	DESCRIPTION
LSCRCB	Irrico-L Collector Ring Brush

Product Details

- Standard brush to suit Irrico-L collector rings
- Sold individually, 2 required per track



Irrico-V Collector Ring Brushes

CODE	DESCRIPTION
VSCRCB	Irrico-V Collector Ring Brush

Product Details

- Standard brush to suit Irrico-V collector rings
- Sold individually, 2 required per track



Changeover Switch 6-Pole

CODE	DESCRIPTION
COS6P	Changeover Switch 6-Pole

Product Details

- On-Off 6 pole switch



CONTACTORS, TRANSFORMERS & SWITCHES

AC Contactor UL & CE (3P)

CODE	DESCRIPTION
CKYC2-25/3	Contacteur - 3 Pole 480V 50/60Hz 25 Amp
CKYC2-40/3	Contacteur - 3 Pole 480V 50/60Hz 40 Amp

Product Details

- Normally open contacts
- 110 Volt coil



AC Contactor UL & CE (4P)

CODE	DESCRIPTION
CKYC2-40/4	Contacteur - 4 Pole 480V 50/60Hz 40 Amp

Product Details

- Normally open contacts
- 110 Volt coil



AC Contactor Schneider

CODE	DESCRIPTION
LC1D18	Contacteur - 3 Pole 380/400V 18 Amp
LC1D25	Contacteur - 3 Pole 380/400V 25 Amp

Product Details

- Normally open contacts
- 110 Volt coil



Main Panel Circuit Breaker Schneider

CODE	DESCRIPTION
A9F29310	Mini Circuit Breaker 400 Volt 50/60 Hz D Series 10A
A9F29316	Mini Circuit Breaker 400 Volt 50/60 Hz D Series 16A

Product Details

- Used in control panels to protect against overload and short circuits in the system



Main Panel Transformers

CODE	DESCRIPTION
JBK5-400	400VA Transformer
JBK5-500	500VA Transformer

Product Details

- Input 380/480V
- Output 110V/24V



SOLID STATE TIMERS

Artisan Solid State Timers

CODE	DESCRIPTION
438USAS	Adjustable Delay Start Solid State Timer - 19 -288V
438FS-115-2S	Solid State Timer 2 Sec Delay Start - 115V AC

Product Details

- Control the delay in the tower boxes
- 438USAS Multi Voltage Delay Start timer 1-1024s
- 438FS-115-2S Fixed Voltage 115V AC, 2 sec Delay
- Made in USA



438USAS



438FS-115-2S

CONTROL SYSTEMS

Standard Control Panel

CODE	DESCRIPTION
IR-BASIC	Basic On/Off Pivot Panel

Product Details

- Basic pivot panel in stainless steel cabinet
- Can be used as replacement for any 110vac Centre Pivot



B-Hyve AG

Pivot Remote Control

CODE	DESCRIPTION
BHAG-WiFi	Multi machine, fully integrated Wi-Fi solution
BHAG-4G	Single machine 4G standalone system

Product Details

- Full pivot remote control system via smartphone app
- No subscription fees
- Wi-Fi or 4G options available
- Wi-Fi option requires connection to existing farm internet
- 4G option requires mobile data plan



IRRICO VALVES

Plastic Irrigation Valves

Product Details

- Sizes, 20, 25,40, 50, 80, 100 & 150mm
- Plumbing Options: Basic, Electric on/off, Reducing, Sustaining, Relief
- Coil Options: 24Vac, 110Vac & Latching DC
- Table D/E Flange Options on 100 & 150mm Valves



IN-V2024A



IN-V2524A



IN-V4024A



IN-V50B3W



IN-V8024A



IN-V100B3W



IN-V150B

Plastic Air Relief Valves

Product Details

- New PN12 pressure rating for valves
- Valve sizes 20, 25 and 50mm with MBSP thread
- All valves fitted with plug-in base for gauge or pressure checkpoint fitment
- All valves with extremely low-pressure sealing feature
- All 50mm valves with threaded outlet to enable in-field fitment of surge protection or inflow protection
- Extremely high air flow on 25mm and 50mm valves making suitable for larger diameter pipeline air flow control and protection
- 50mm valve has a threaded outlet 50mm FBSP
- 20mm and 25mm valves have a 20mm hole on the outlet
- Valves fully approved for drinking water installations to AS4956 & AS4020
- Valves appraised by WSAA (PA 2042)



IRRICO SPRINKLERS

Irrigation Sprinklers

Product Details

- Sizes, 15 & 20mm MBSP
- Plastic and Brass Construction
- Part Circle and Full Circle options available
- High CU's and DU's
- Proven Long Life Expectancy Under Harsh Australian Conditions
- Cost Effective Alternative to Other Major Brands
- Horticultural Favourite for over 20 years
- Perfect for Horticultural, Dairy & Pasture Irrigation

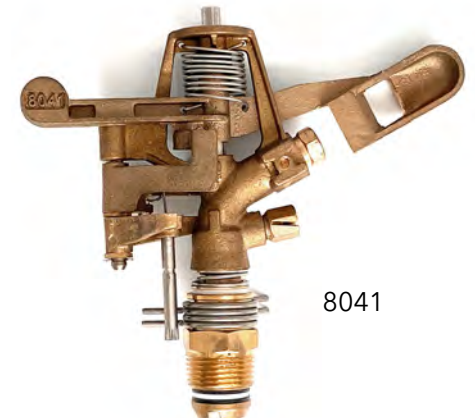



XCAD
USA™

XCAD USA

END OF PIVOT SPRINKLERS & NOZZLES

XCAD Axis Sky (upright) & Field (inverted) Sprinklers

CODE	DESCRIPTION
AXIS-S	Upright Low Pressure Pivot End Sprinkler
AXIS-F	Inverted Low Pressure Pivot End Sprinkler

Product Details

- New 'V-Torque' brass dampener
- Easy nozzle assembly and replacement
- 15 to 50 psi working pressure
- Comes with a full set of nozzles: #12,15,18 & 21
- 1 ¼" BSP base
- Use in conjunction with X100 End Gun sprinkler for added acreage and improved coverage
- Built in USA



XCAD X75 Black Bird Sprinkler

CODE	DESCRIPTION
X7518	Black Bird Sprinkler 18 Degree with full nozzle set
X7527	Black Bird Sprinkler 27 Degree with full nozzle set

Product Details

- Comes standard with 8 nozzles : Sizes 3, 3.5, 4, 4.5, 5, 5.5, 6 and 6.5
- Powder-coated nozzle mount, drive arm and body
- 18° trajectory pivot end gun
- 27° trajectory movable solid set
- 18 - 100 gpm, 40 - 90 psi
- Full and part circle
- Replaceable spoon
- 2" NPT male thread, 1 1/2" NPT female thread
- High quality composite bearings
- Replacement for Nelson SR75



HIGH PRESSURE END GUNS

XCAD X100 Thunderbolt End Gun

CODE	DESCRIPTION
X10018	18 Degree
X10024	24 Degree

Product Details

- 2.3 - 18.3 l/sec, 35 - 100 psi
- 18° trajectory - Pivot end gun
- 24° trajectory - Travelling irrigator gun
- Consistent forward and reverse speeds
- Adjustable control from 30° to 360°
- 2" Female BSP inlet



XCAD X100 Nozzle

CODE	DESCRIPTION
X100-42-xxx	0.4"-1.0"

Product Details

- Nozzle sizes from 0.4"-1.0", 0.05 increments
- Compatible with Nelson SR75 big guns



XCAD X100 Replacement Bearing Assembly

CODE	DESCRIPTION
X100-BA	Complete Bearing Assembly

Product Details

- Anodized aluminium body and bearing stem
- One-piece brass bearing base carrier with Aqua Burst® exclusive UltraSlip impregnated o-ring
- Heavy-duty wastewater bearing assembly includes stainless-steel ball bearings, bearing stem, bearing nut, bearing carrier and base flange



PIVOT SPRINKLERS

XCAD RADIUS

CODE	DESCRIPTION
RADIUS-BK	Black Plate
RADIUS-BL	Blue Plate
RADIUS-P	Purple Plate
RSJPACK	Dual Nozzle Carrier

Product Details

- Quick click rotary nozzle with Run, Off, and Flush modes
- Optional nozzle carrier Jet Pack™ for 2 extra on-board nozzles
- Available in 3 pad configurations: Black, Blue, Purple
- Working pressure 6 - 20 psi
- Black Plate: Multi size droplets with maximum Radius to help prevent runoff
- Blue Plate: Large droplets at a low trajectory for high wind applications
- Purple Plate: Small droplets for tight soils to help prevent soil sealing
- The Radius Jet Pack Nozzle Storage System allows for two extra nozzles for when water availability or water application needs increased or decreased as crop matures.
- Jet Pack Nozzle Holder allows you to match crop water requirements throughout the growing season



RADIUS-P



RSJPACK
Nozzles not included

PIVOT REGULATORS

XCAD XPR Regulators

CODE	DESCRIPTION
XPR-6	6 PSI Pressure Regulator
XPR-10	10 PSI Pressure Regulator
XPR-15	15 PSI Pressure Regulator
XPR-20	20 PSI Pressure Regulator

Product Details

- Allow at least 5 PSI (.35 BAR) extra pressure in order for the Aquaburst XP Regulator to function properly.
- Aquaburst XPR Pressure Regulator has a flow of 5 to 15 gpm.
- 3/4 FNDR conditions



XPR-20

VALVES

Product Details

- Built in the USA
- Five-Year Diaphragm Warranty
- Hot dipped galvanized and oven baked powder coatings
- Pilot control options: pressure reducing, pressure sustaining and pressure relief
- Electric on/off with Parker Skinner solenoid and manual three-way controller
- Solenoid available in 12v DC, 24v DC or 120v AC
- Available with P-6000 brass pilot
- Manual three-way controller
- Bolt kit included



XMAX4WS

X-MAX Basic Valve

CODE	DESCRIPTION
XMAX4B	4" Basic w/Plugs
XMAX6II-B	6" Basic w/Plugs
XMAX8B	8" Basic w/Plugs

X-MAX Electric On/Off Valve

CODE	DESCRIPTION
XMAX4WS	4" w/Solenoid
XMAX6II-WS	6" w/Solenoid
XMAX8WS	8" w/Solenoid



XMAX6II-WS

X-MAX Manual Pressure Reducing Valve

CODE	DESCRIPTION
XMAX4MPR	4" w/P-6000 Pilot
XMAX6II-MPR	6" w/P-6000 Pilot
XMAX8MPR	8" w/P-6000 Pilot

X-MAX Electric On/Off Pressure Reducing Valve

CODE	DESCRIPTION
XMAX4EPR	4" w/P-6000 Pilot/Solenoid
XMAX6II-EPR	6" w/P-6000 Pilot/Solenoid
XMAX8EPR	8" w/P-6000 Pilot/Solenoid



XMAX8WS

X-MAX Manual Pressure Sustaining Valve

CODE	DESCRIPTION
XMAX4MPS	4" w/P-6000 Pilot
XMAX6II-MPS	6" w/P-6000 Pilot
XMAX8MPS	8" w/P-6000 Pilot

Seal Matic Control Valves

Product Details

- Fully galvanized, ductile iron body and bonnet
- Brass auto-drain option available on 3/4" to 2" Valves:
Add code PEG to order code
- One diaphragm for all working pressures
- 200 psi max working pressure
- Easy in-place maintenance
- SMVX100PEG is interchangeable with Aqua Burst X-100 and Nelson SR100 and SR75
- New Super Flow design, available in 4", 6", 8"
- Fully open at 5 psi
- CIT tested flow rates
- Pilot Control Options: Pressure reducing, pressure sustaining, pressure relief
- Pressure reducing and pressure sustaining valves come with P-6000 brass pilot
- Solenoid available in 12v DC, 24v AC, 24v DC or 120v AC
- Manual three-way controller



3/4", 1", 1 1/4" & 1 1/2" Valves



2" x 90 Degree



2" In-line valve



2" Valve to Suit X100, SR75 & SR100 End Guns



4" Flanged valve



6" & 8" Dual Diaphragm Flanged Valves

XCad Valve Plumbing

ODE	DESCRIPTION
PKSOL-120AC	110-120V AC 3-W Potted Coil
SVB-4	Brass Shuttle Valve 1/4"
PLTVENT	Brass Vent Nozzle For Pilot
BHN2-2	1/8" x 1/8" NPT Brass Hex Nipple
SE4-2	Swivel Elbow 1/4" x 1/8" NPT
SE4-4	Swivel Elbow 1/4" x 1/4" NPT
NSSC4-2	Speed Cont. Valve 1/4"H x 1/8" NPT
NSSC4-4	Speed Cont. Valve 1/4"H x 1/4" NPT
LBF25	1/4" x 1/4" Long Brass Filter
SRT4-2	Swivel Run Tee 1/4" x 1/8" NPT
3WSEL	3 Way Selector Valve 1/4" x 1/8" x 1/8" x 1/8"
BVT14	1/4" Nylon Tubing (per linear metre)



PKSOL-120AC



SVB-4



PLTVENT



BHN2-2



SE4-2



SE4-4



NSSC4-2



NSSC4-4



LBF25



SRT4-2



3WSEL



BVT14

DRAINS

XCAD Z Drain

CODE	DESCRIPTION
ZDCOMP	Complete Drain Assembly
ZDBASE	Base
ZDGROM	Rubber Grommet
ZDBGS	Base & Grommet Set
SDMC-1	Metal Cap
SDRS-1	Neoprene Rubber Star Gasket

Product Details

- 7/8" hole replacement drain for Irrico-L pivot systems
- Converts mushroom-type to star-drain type
- Easy external installation



XCAD V Drain

CODE	DESCRIPTION
SDPBC-1	Complete with Plastic Base
SDMC-1	Metal Cap
SDRS-1	Neoprene Rubber Star
SDPB-1	Plastic Base

Product Details

- 1" NPT replacement drain for Irrico-V pivots



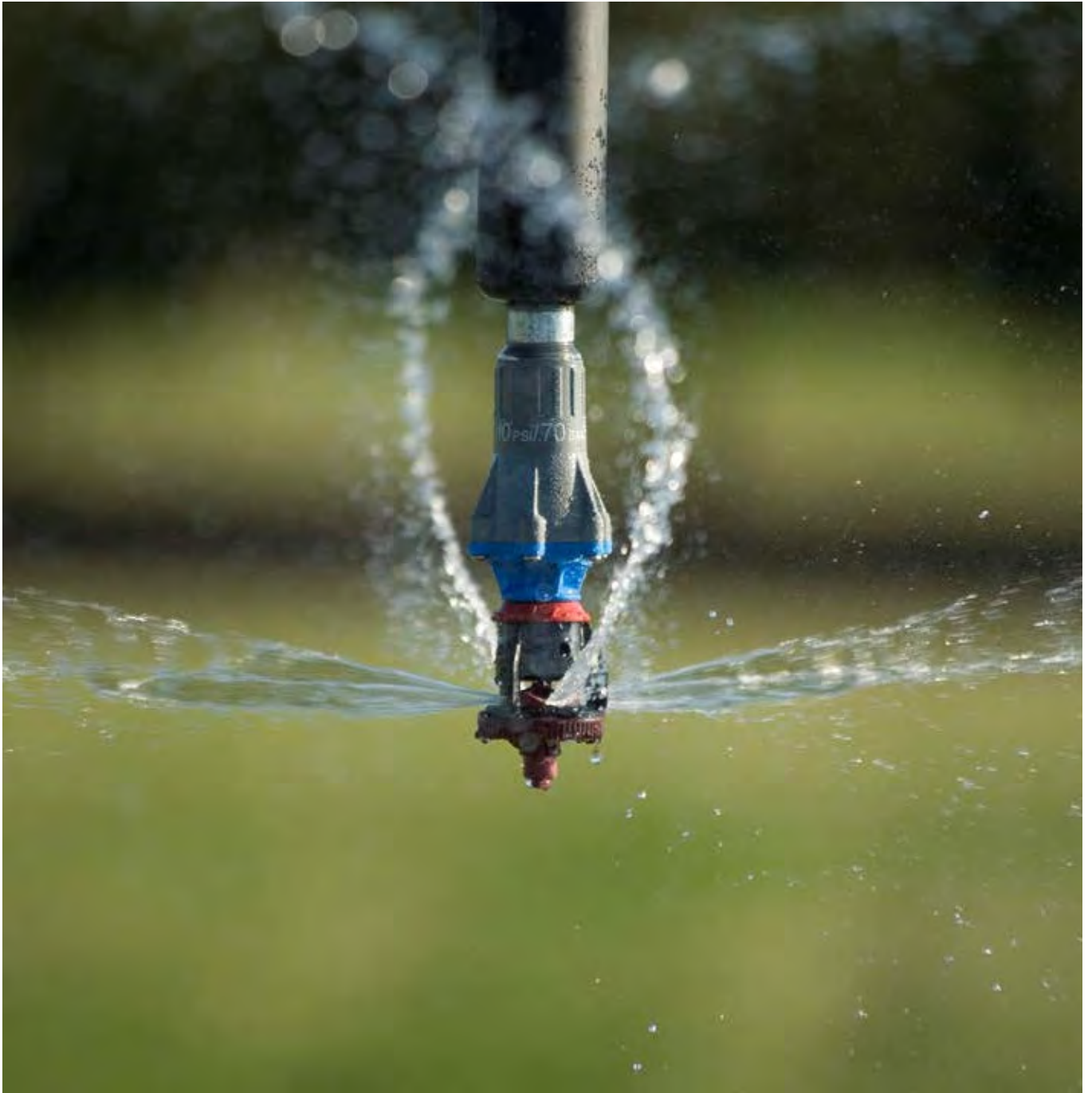

NELSON

SPRINKLERS & PARTS

Nelson R3030 & R3000: Rotator

CODE	DESCRIPTION
9410	3000 Adapter Square Thread x 3/4" MNPT
	Rotator Plates (See below)
9539	R3000 Cap/Motor
12035-xxx	3NV Nozzle
12034	R3030/S3030 Body
	R3030 Components Total (Inc Nozzle & Adapter)
11969	Cap/Plate Assembly
12471	R3030 Cap/Plate Body Assembly
9461-xxx	3TN Nozzle
9412	R3000/S3000 Body
	R3000 Components Total (Inc Nozzle & Adapter)
11969	Cap/Plate Assembly
11970	R3000 Cap/Plate Body Assembly

** xxx refers to nozzle size from nozzle size chart on pg 68



R3030



R3000

BLUE UP-TOP U4-8° #8817	WHITE UP-TOP #10749	GREEN D4-8° #8844	RED D6-12° #8839	ORANGE MULTI-TRAJECTORY #10598	BROWN MULTI-TRAJECTORY #10681	OLIVE MULTI-TRAJECTORY #12360
						
Cap/Plate Assy #11969-001	Cap/Plate Assy #11969-002	Cap/Plate Assy #11969-003	Cap/Plate Assy #11969-004	Cap/Plate Assy #11969-005	Cap/Plate Assy #11969-006	Cap/Plate Assy #11969-007
R3030 Cap/Plate Body Assy #12471-001	R3030 Cap/Plate Body Assy #12471-002	R3030 Cap/Plate Body Assy #12471-003	R3030 Cap/Plate Body Assy #12471-004	R3030 Cap/Plate Body Assy #12471-005	R3030 Cap/Plate Body Assy #12471-006	R3030 Cap/Plate Body Assy #12471-007
R3000 Cap/Plate Body Assy #11970-001	R3000 Cap/Plate Body Assy #11970-002	R3000 Cap/Plate Body Assy #11970-003	R3000 Cap/Plate Body Assy #11970-004	R3000 Cap/Plate Body Assy #11970-005	R3000 Cap/Plate Body Assy #11970-006	R3000 Cap/Plate Body Assy #11970-007
1.4-3.4 bar (20-50 PSI)	1.0-2.0 bar (15-30 PSI)	1.4-3.4 bar (20-50 PSI)	1.0-2.0 bar (15-30 PSI)	1.0-2.0 bar (15-30 PSI)	1.0-2.0 bar (15-30 PSI)	.7-1.7 bar (10-25 PSI)

Nelson S3030 & S3000: Spinner

CODE	DESCRIPTION
9410	3000 Adapter Square Thread x 3/4" MNPT
	Spinner Plates (See Below)
9540	S3000 Cap/Motor
12035-xxx	3NV Nozzle
12034	R3030/S3030 Body
	S3030 Components Total (Inc Nozzle & Adapter)
11971	Cap/Plate Assembly
12472	S3030 Cap/Plate Body Assembly
9461-xxx	3TN Nozzle
9412	R3000/S3000 Body
	S3030 Components Total (Inc Nozzle & Adapter)
11971	Cap/Plate Assembly
11972	S3000 Cap/Plate Body Assembly

** xxx refers to nozzle size from nozzle size chart shown below



S3030



S3000

RED D6-12° #8839	PURPLE D6-20° #9583	YELLOW D8-21° #10361	BEIGE SMALL NOZZLE #11013
Cap/Plate Assy #11971-001	Cap/Plate Assy #11971-002	Cap/Plate Assy #11971-003	The beige plate should be used on flexible drops, or those with at least 0.3m (1ft.) of hose. The smaller nozzles will be more susceptible to plugging.
S3030 Cap/Plate Body Assy #12472-001	S3030 Cap/Plate Body Assy #12472-002	S3030 Cap/Plate Body Assy #12472-003	
S3000 Cap/Plate Body Assy #11972-001	S3000 Cap/Plate Body Assy #11972-002	S3000 Cap/Plate Body Assy #11972-003	
0.7-1.4 bar (10-20 PSI)	0.7-1.4 bar (10-20 PSI)	0.7-1.4 bar (10-20 PSI)	0.7-1.0 bar (10-15 PSI)

3NV & 3TN NOZZLE SIZE CHART

Nozzle #	#9	#10	#11	#12	#13	#14	#15	#16	#17	#18	#19	#20
Inches	9/128	5/64	11/128	3/32	13/128	7/64	15/128	1/8	17/128	9/64	19/128	5/32
mm	1.8	2.0	2.2	2.4	2.6	2.8	3.0	3.2	3.4	3.6	3.8	4.0
Nozzle #	#21	#22	#23	#24	#25	#26	#27	#28	#29	#30	#31	#32
Inches	21/128	11/64	23/128	3/16	25/128	13/64	27/128	7/32	29/128	15/64	31/128	1/4
mm	4.2	4.4	4.6	4.8	5.0	5.2	5.4	5.6	5.8	6.0	6.2	6.4
Nozzle #	#33	#34	#35	#36	#37	#38	#40	#42	#44	#46	#48	#50
Inches	33/128	17/64	35/128	9/32	37/128	19/64	5/16	21/64	11/32	23/64	3/8	25/64
mm	6.5	6.7	6.9	7.1	7.3	7.5	7.9	8.3	8.7	9.1	9.5	9.9

Nelson A3030 & A3000: Accelerator

CODE	DESCRIPTION
9410	3000 Adapter Square Thread x 3/4" MNPT
	Rotator Plates (See Below)
10402	A3000 Cap/Motor
12035-xxx	3NV Nozzle
12346	A3030 Body/D3030
	A3030 Components Total (Inc Nozzle & Adapter)
11498	Cap/Plate Assembly
12473	A3030 Cap/Plate Body Assembly
9461-xxx	3TN Nozzle
9428	A3000 Body
	A3000 Components Total (Inc Nozzle & Adapter)
11498	Cap/Plate Assembly
11973	A3000 Cap/Plate Body Assembly

** xxx refers to nozzle size from nozzle size chart on pg 68

MAROON #9906	GOLD	NAVY UP-TOP
		
Cap/Plate Assy #11498-001	Cap/Plate Assy #11498-002	Cap/Plate Assy #11498-003
A3030 Cap/Plate Body Assy #12473-001	A3030 Cap/Plate Body Assy #12473-002	A3030 Cap/Plate Body Assy #12473-003
A3000 Cap/Plate Body Assy #11973-001	A3000 Cap/Plate Body Assy #11973-002	A3000 Cap/Plate Body Assy #11973-003
0.4-1.0 bar (6-15 PSI)	0.4-1.0 bar (6-15 PSI)	0.4-1.0 bar (6-15 PSI)



A3030



A3000

Nelson O3030: Orbitor

CODE	DESCRIPTION
9410	3000 Adapter Square Thread x 3/4" MNPT
12035-xxx	3NV Nozzle
12317-30	O3030 With Plastic Cover
	O3030 Components Total (Plastic Cover)
12317-10	O3030 Body & Weight
	O3030 Components Total (Weighted Cover)

** xxx refers to nozzle size from nozzle size chart on pg 68

BLACK STANDARD ANGLE	BLUE LOW ANGLE	PURPLE SMALL DROPLET
		
O3030 Assy w/ Weight #12317-101 Plastic Cover Version #12317-301 O3000 Assy w/ Weight #11488-101 Plastic Cover Version #11488-301	O3030 Assy w/ Weight #12317-102 Plastic Cover Version #12317-302 O3000 Assy w/ Weight #11488-102 Plastic Cover Version #11488-302	O3030 Assy w/ Weight #12317-103 Plastic Cover Version #12317-303 O3000 Assy w/ Weight #11488-103 Plastic Cover Version #11488-303
0.7-1.4 bar (10-20 PSI)	0.7-1.4 bar (10-20 PSI)	0.7-1.4 bar (10-20 PSI)



Nelson D3030 & D3000: Sprayhead

CODE	DESCRIPTION
9410	3000 Adapter Square Thread x 3/4" MNPT
	Spray Plates (See Below)
9429	D3000 Cap
12035-xxx	3NV Nozzle
12346	A3030/D3030 Body
	D3030 Components Total (Inc Nozzle & Adapter)
10041	Cap/Plate Assembly
9461-xxx	3TN Nozzle
9428	D3000 Body
	D3000 Components Total (With One Spray Plate)
10041	Cap/Plate Assembly
11498	Cap/Plate Assembly
11973	A3000 Cap/Plate Body Assembly

** xxx refers to nozzle size from nozzle size chart on pg 68

GREEN #9543 	YELLOW #9631 	PURPLE #9550 	BLUE #9493 
BLACK #9541 	GREY #9542 	ORANGE #10683 	BROWN #10721 
TURQUOISE #9591 	RED #9437 	WHITE #10971 	TAN #12780 



D3030



D3000

LOW PRESSURE END GUNS

Nelson R55 & R55i End Gun

CODE	DESCRIPTION
12885	R55 VT Body End Gun Rotator with Adapter (No Nozzle)
12679-0xx	Nozzle Assembly MNPT
12679-1xx	Nozzle Assembly MBSP
	Complete R55 VT (Body & Nozzle Assembled)
12886	R55i VT Body End Gun Rotator with Adapter (No Nozzle)
12679-0xx	Nozzle Assembly MNPT
12679-1xx	Nozzle Assembly MBSP
	Complete R55i VT (Body & Nozzle Assembled)



R55

Product Details

- Patented variable torque speed governing system that allows the plate to maintain a constant rotation speed.
- Maximum radius of throw up to 16.9m.
- Incorporates snap-fit nozzles, eliminating the need for a retaining pin to secure the nozzle to the sprinkler body.



R55i

R55 PERFORMANCE (METRIC UNITS)

Pressure (bar)	#52 Purple Nozzle		#56 White Nozzle		#60 Red Nozzle		#65 Orange Nozzle		#70 Yellow Nozzle		#80 Green Nozzle		#90 Blue Nozzle	
	Flow (m³/hr)	Radius (m)	Flow (m³/hr)	Radius (m)	Flow (m³/hr)	Radius (m)	Flow (m³/hr)	Radius (m)	Flow (m³/hr)	Radius (m)	Flow (m³/hr)	Radius (m)	Flow (m³/hr)	Radius (m)
1.0	4.2	12.2	5.3	12.2	6.3	12.2	7.4	12.2	8.2	12.2	10.3	12.2	11.8	12.5
1.5	5.1	13.3	6.4	13.4	7.6	13.4	9.0	13.7	10.0	13.8	12.5	13.8	14.4	14.0
2.0	6.0	14.0	7.5	14.3	8.9	14.3	10.5	14.6	11.6	14.9	14.6	14.9	16.7	15.1
2.5	6.7	14.4	8.4	14.7	10.0	15.0	11.8	15.0	13.1	15.3	16.4	15.3	18.8	15.6
3.0	7.4	14.6	9.2	15.2	11.0	15.5	13.0	15.5	14.4	15.8	18.0	16.0	20.6	16.3
3.5	8.0	14.6	9.9	15.2	11.8	15.5	14.1	15.8	15.5	16.2	19.4	16.5	22.2	16.5
4.0	8.5	14.6	10.5	15.2	12.5	15.5	15.0	15.8	16.4	16.2	20.5	16.5	23.6	16.9

R55i PERFORMANCE (METRIC UNITS)

Pressure (bar)	#52 Purple Nozzle		#56 White Nozzle		#60 Red Nozzle		#65 Orange Nozzle		#70 Yellow Nozzle		#80 Green Nozzle	
	Flow (m³/hr)	Radius (m)	Flow (m³/hr)	Radius (m)	Flow (m³/hr)	Radius (m)	Flow (m³/hr)	Radius (m)	Flow (m³/hr)	Radius (m)	Flow (m³/hr)	Radius (m)
1.0	4.2	11.6	5.3	11.6	6.3	11.3	7.4	11.3	8.2	11.0	10.3	10.7
1.5	5.1	12.5	6.4	12.8	7.6	12.4	9.0	12.4	10.0	12.1	12.5	11.8
2.0	6.0	13.4	7.5	13.7	8.9	13.3	10.5	13.3	11.6	13.0	14.6	12.7
2.5	6.7	13.8	8.4	14.1	10.0	13.9	11.8	13.8	13.1	13.6	16.4	13.3
3.0	7.4	14.2	9.2	14.5	11.0	14.5	13.0	14.2	14.4	14.2	18.0	13.9
3.5	8.0	14.4	9.9	14.7	11.8	14.7	14.1	14.6	15.5	14.4	19.4	14.1
4	8.5	14.8	10.5	14.9	12.5	14.9	15.0	14.6	16.4	14.6	20.5	14.3

Nelson R75 & R75LP End Gun

CODE	DESCRIPTION
11936-001	R75 Body End Gun Rotator with Adapter (No Nozzle)
11936-002	R75LP Body (Low Pressure) End Gun Rotator with Adapter (No Nozzle)
12178-0xx	7TN Nozzle (Beige -052, Red -056, Yellow -060, Green -064, Blue -068, White -072)



Product Details

- Unique dual barrel spray plate provides both distance & uniformity
- Adjustable stops achieve best arc of coverage for running a single sprinkler, dual R75, or as a secondary with a Big Gun® Sprinkler
- The spray plate is easily removable to gain access to the nozzle should you need to change or unplug the sprinkler
- Available with 1 3/4" MNPT or MBSP connections

R75 & R75LP PERFORMANCE (METRIC UNITS)

Pressure (bar)	#52 Beige		#56 Red		#60 Yellow		#64 Green		#68 Blue		#72 White		
	Flow (m³/hr)	Radius (m)	Flow (m³/hr)	Radius (m)	Flow (m³/hr)	Radius (m)	Flow (m³/hr)	Radius (m)	Flow (m³/hr)	Radius (m)	Flow (m³/hr)	Radius (m)	
R75LP	1.75	5.4	14.9	6.3	15.5	7.1	16.2	8.1	16.8	9.2	16.8	10.2	17.1
	2.00	5.8	15.5	6.7	16.2	7.6	16.5	8.7	17.4	9.8	17.4	10.9	17.7
	2.50	6.4	16.5	7.5	16.8	8.5	16.8	9.7	18.0	10.9	18.0	12.1	18.3
	2.75	6.8	16.5	7.8	17.1	9.0	17.1	10.2	18.0	11.5	18.3	12.7	18.6
R75	2.75	6.8	17.4	7.8	18.0	9.0	18.6	10.2	19.8	11.5	19.8	12.7	19.5
	3.00	7.1	17.7	8.2	18.3	9.4	18.9	10.6	20.1	12.0	20.1	13.3	19.8
	3.50	7.7	18.0	8.9	18.6	10.2	19.2	11.5	20.4	13.0	20.4	14.4	19.8
	4.00	8.2	18.0	9.5	18.9	10.9	19.8	12.3	21.0	13.9	20.7	15.4	20.4

HIGH PRESSURE END GUNS

Nelson End Gun Sprinklers

CODE	DESCRIPTION
SR75	Part Circle – Slow Reverse (18°)
TR75	Individual Taper Ring Nozzle – Specify Size (0.5" - 0.8")
SR100	Part Circle – Slow Reverse (18°)
SRNV100E	SR100 Nozzle Valve w/Solenoid (110V or 24V) (18°)
SRNV100H	SR100 Nozzle Valve without Solenoid
SRNV100DP	SR100 Nozzle Valve w/ Delta P (less nozzle)
100T	Taper Bore Nozzle – Specify Size (0.5" - 1.0")

Product Details

- The SR75 is an excellent option when flow or pressure are limited, but long range is still desired. When irrigating a full circle, it can account for up to 17 additional acres (6.9 ha) on a standard 400m centre pivot, or up to 9 additional acres (3.6 ha) when operating in the corners only
- The SR100 Big Gun sprinkler (operating through a complete rotation) on a quarter-section pivot can effectively irrigate up to 20 additional acres (8.1 ha). Considering the cost-effectiveness of putting this additional land into production, an end gun alternative shouldn't be overlooked



SR75



SR100

REGULATORS

Nelson Pressure Regulators

CODE	DESCRIPTION
9572-xxx	Square Thread Uni-Flo
9611-xxx	Square Thread Hi-Flo
9491-xxx	3/4" FNPT Uni-Flo
9071-xxx	3/4" FNPT Hi-Flo

** Order replacing xxx with appropriate code from table below



	6 PSI (0.4 bar)	10 PSI (0.7 bar)	15 PSI (1.0 bar)	20 PSI (1.4 bar)	25 PSI (1.7 bar)	30 PSI (2.1 bar)	40 PSI (2.8 bar)	50 PSI (3.4 bar)
3/4" FNPT X SQUARE THREAD UNI-FLO	9572-001	9572-002	9572-003	9572-004	9572-005	9572-006	9572-007	9572-008
3/4" FNPT X SQUARE THREAD HI-FLO	9611-001	9611-002	9611-003	9611-005	9611-006	9611-007	9611-008	9611-009
3/4" FNPT X 3/4" FNPT UNI-FLO	9491-001	9491-002	9491-003	9491-004	9491-005	9491-006	9491-007	9491-008
3/4" FNPT X 3/4" FNPT HI-FLO	9071-001	9071-002	9071-003	9071-005	9071-006	9071-007	9071-008	9071-009

Nelson Pivot Pressure Regulators PPR ALL-FLO

CODE	DESCRIPTION
12616-xxx	Square Threaded All-Flo
12612-xxx	3/4" FNPT x 3/4" FNPT All-Flo

** Order replacing xxx with appropriate code from table below



	6 PSI (0.4 bar)	10 PSI (0.7 bar)	15 PSI (1.0 bar)	20 PSI (1.4 bar)	25 PSI (1.7 bar)	30 PSI (2.1 bar)	40 PSI (2.8 bar)	50 PSI (3.4 bar)	60 PSI (4.1 bar)
3/4" FNPT X SQUARE THREAD ALL-FLO	12616-006	12616-010	12616-015	12616-020	12616-025	12616-030	12616-040	12616-050	12616-060
3/4" FNPT X 3/4" FNPT ALL-FLO	12612-006	12612-010	12612-015	12612-020	12612-025	12612-030	12612-040	12612-050	12612-060



**Senninger**[®]

SENNINGER

SPRINKLERS & PARTS

Senninger I-Wob 2

CODE	DESCRIPTION
IWOB200B3UP3	I-Wob 2 Standard Angle Black Deflector
IWOB200B3LA9UP3	I-Wob 2 Low Angle Blue Deflector
IWOB200BSA6UP3	I-Wob 2 Standard Angle Grey Deflector
IWOB200B3LAUP3	I-Wob 2 Low Angle White Deflector

Product Details

- The I-Wob2 with double nozzle carrier
- Extremely reliable
- Good droplet size for low evaporative loss
- Excellent throw distance
- True low-pressure operation



Senninger XI-Wob

CODE	DESCRIPTION
XIWOB00B3615UP3	XI-Wob with 6 Groove Black Deflector
XIWOB00B3610UP3	XI-Wob with 6 Groove Blue Deflector
XIWOB00B3910UP3	XI-Wob with 6 Groove Grey Deflector

Product Details

- Wobbler® technology produces low application intensity to preserve soil integrity
- Gentle application
- Extremely reliable
- Good droplet size for low evaporative loss
- Excellent throw distance
- True low-pressure operation



Senninger LDN Bracket

CODE	DESCRIPTION
LDNBRASMUP3	UP3 Bare Bracket and Cage

Product Details

- ¾" LDN bracket and cage
- Nozzle and pad sold separately
- Extremely reliable



Senninger LDN Single Pad

CODE	DESCRIPTION
LDNPHDC	Concave Blue Deflector Pad

Product Details

- LDN single pad
- Nozzle and bracket not included
- Blue plate, convex, 33 streams



Senninger LDN Double Pad

CODE	DESCRIPTION
LDNDBLPADCOMP	Blue/Black

Product Details

- LDN double pad
- Nozzle and bracket not included
- Blue plate, convex, with black plate flat, 66 streams



Senninger LDN Triple Pad

CODE	DESCRIPTION
LDNTRIPADCOMP	Blue/Black/Green

Product Details

- LDN triple pad
- Nozzle and bracket not included
- Blue plate, convex, black plate flat, green plate convex, 99 streams



Senninger LDN Half Circle

CODE	DESCRIPTION
LDNPHDPCCDG17	Part Circle Deep Groove Blue

Product Details

- 10-degree trajectory
- 17 streams
- 170-degree pattern
- Nozzle and bracket not included



Senninger LDN Shroud

CODE	DESCRIPTION
LDNSUP3	Black Plastic

Product Details

- Forms hollow cone spray pattern for LEPA application
- Works best at 10psi



Senninger UP3 Bubbler Pad

CODE	DESCRIPTION
LDNPHDUP3B	Flat Smooth Black Deflector Pad

Product Details

- Works on 6-15psi
- Prevent wind drift losses
- Avoids wetting plant canopy
- 10cm diameter aerated bubble pattern in LEPA mode
- Suitable for cracking clays



Senninger Magnum Weight Slip

CODE	DESCRIPTION
MAGWGTSLP	Black Plastic Weight

Product Details

- 0.85lb / 0.39 kgs
- Easy to install
- For use with LDN, X i-Wob, and other brands of pivot sprinklers



Senninger Magnum Weight Threaded (for i-Wob)

CODE	DESCRIPTION
MAGWGTRB	Black Plastic Weight

Product Details

- 0.85lb / 0.39 kgs
- Easy to install
- Ensure weight is tightly threaded to i-Wob



Senninger UP3 Nozzles

CODE	DESCRIPTION
UP3NZxxx	Sizes from #4 - #26

Product Details

- Pinch & Pull to remove and Push & Click to install UP3 nozzles



Senninger UP3 Dual Nozzle Carrier

CODE	DESCRIPTION
UP3NZCD	Dual Nozzle Carrier

Product Details

- Excludes nozzles



REGULATORS

Senninger PSR (Pivot Special) Regulators

CODE	DESCRIPTION
PSR2063F3F	PSR2 3/4" FNPT 6 PSI Regulator
PSR2103F3F	PSR2 3/4" FNPT 10 PSI Regulator
PSR2153F3F	PSR2 3/4" FNPT 15 PSI Regulator
PSR2203F3F	PSR2 3/4" FNPT 20 PSI Regulator

Product Details

- 100% pressure tested, to ensure quality and performance
- Very low hysteresis and friction loss
- Two-year warranty on workmanship, materials and performance



GAUGES

Senninger Pressure Drop Gauge

CODE	DESCRIPTION
PRESDRP30FP	0-30 psi
PRESDRP60FP	0-60 psi

Product Details

- Recommended for use on the last drop of all sprinkler packs
- Ensure optimum regulator pressure, at least 5psi above regulator operating pressure
- 0-30psi and 0-60psi models available



HOSE, GOOSENECKS & FITTINGS

Senninger Poly Nipples

CODE	DESCRIPTION
FTN33D	3/4" x 3/4" NPT



Senninger Poly Hose Tails

CODE	DESCRIPTION
FTA3M3B	3/4" Male x 3/4" Barb
FTA3F3B	3/4" Female x 3/4" Barb



NPT Threaded Plug

CODE	DESCRIPTION
FTP3	¾" NPT Plastic Plug



Hose Clamps

CODE	DESCRIPTION
109438	1 1/16" x 3/4" Stainless Steel Hose Clamps

Product Details

- Stainless steel hose clamp for dropper hose connection



Knipex Clamp Crimping Tool

CODE	DESCRIPTION
5001225	225mm
5001250	250mm

Product Details

- Specifically designed for use with crimp hose clamps



Senninger Dropper Hose

CODE	DESCRIPTION
DH76BK	Black
DH76BL	Blue

Product Details

- 19mm x 76m roll



Senninger Gooseneck 180 Degree Single

CODE	DESCRIPTION
GNAP180X6B	Male x Barb
GNAP180X6M	Male x Male

Product Details

- Lightweight for easier handling and installation
- For use with truss rod clips
- Connections: Single 3/4" hose or 3/4" M NPT outlet
- Strong UV stable thermoplastic



Senninger Gooseneck 125 Degree Single

CODE	DESCRIPTION
GNAP125SB	Male x Barb
GNAP125SM	Male x Male

Product Details

- Lightweight for easier handling and installation
- For use with truss rod clips
- Connections: Single 3/4" hose or 3/4" M NPT outlet
- Strong UV stable thermoplastic



Senninger Gooseneck 125 Degree Double

CODE	DESCRIPTION
GNAP125DB	Male x Barb
GNAP125DM	Male x Male

Product Details

- Lightweight for easier handling and installation
- For use with truss rod clips
- Connections: Single 3/4" hose or 3/4" M NPT outlet
- Strong UV stable thermoplastic



TRUSS ROD SLINGS

Senninger Truss Rod Slings

CODE	DESCRIPTION
TRHS625	Rust
TRHS687	Green
TRHS750	Black
TRHS812	Grey
TRHS875	Blue

Product Details

- Rust: 5/8"
- Green: 11/16"
- Black: 3/4"
- Grey: 13/16"
- Blue: 7/8"



END SPRAYS

Senninger End Spray

CODE	DESCRIPTION
ESPA4M20	Body with #20 nozzle
ESPA4M26	Body with #26 nozzle
ESPA4M32	Body with #32 nozzle
ESPA4M38	Body with #38 nozzle



Product Details

- No moving parts for longer product life
- Provides good 180° distribution
- Good uniformity over large area to help reduce compaction and run-off
- End Spray must be installed on a 1" F NPT connection
- Great for discharging rust and sand

Valley® is a registered trademark of Valmont Industries, Inc.

Irrico-V are Irrico manufactured components, compatible with some Valley® pivots.

Products listed are from January 1st 2026 & subject to change without notice. Errors & Omissions
Excluded. All images are for illustration purposes only.
© All images and publication content 2026 Irrico Pty Ltd.

IRRICO Pty Ltd

Head Office:
12 Cooroora Crescent
Lonsdale SA 5160

Phone:
(08) 8186 5326

Website:
www.irrico.com.au

Email:
info@irrico.com.au

